

adic

The ADIC
Distributed AML Server

**DAS
Administration
Guide**

 Advanced Digital Information Corp

Copyright Notice

© Copyright **adic** 1999

The information contained in this document is subject to change without notice.

This document contains proprietary information which is protected by copyright. All rights are reserved. No part of this document may be photocopied, reproduced, or translated to another language without prior written consent of **adic**.

adic shall not be liable for errors contained herein or for incidental or consequential damages (including lost profits) in connection with the furnishing, performance or use of this material whether based on warranty, contract, or other legal theory.

All trademarks are property of their respective owners.

Copyright Notice (Europe)

© Copyright **adic** Europe 1999

All rights reserved. No part of this document may be copied or reproduced in any form or by any means, without prior written permission of **adic** Europe, ZAC des Basses Auges, 1 rue Alfres de Vigny, 78112 - Fourqueux, FRANCE.

adic Europe assumes no responsibility for any errors that may appear in this document, and retains the right to make changes to these specifications and descriptions at any time, without notice.

This publication may describe designs for which patents are pending, or have been granted. By publishing this information, **adic** Europe conveys no license under any patent or any other right.

adic Europe makes no representation or warranty with respect to the contents of this document and specifically disclaims any implied warranties of merchantability or fitness for any particular purpose. Further, **adic** Europe reserves the right to revise or change this publication without obligation on the part of **adic** Europe to notify any person or organization of such revision of change.

Every effort has been made to acknowledge trademarks and their owners. Trademarked names are used solely for identification or exemplary purposes, any omission are made unintentionally.

adic and **adic** Europe are trademarks of Advanced Digital Information Corporation.

Advanced Digital Information Corporation
Telephone: (303) 705-3900
Fax: (303) 792-2465
Customer Assistance: 1-800-827-3822
World Wide Web: <http://www.adic.com>

ADIC Europe
ZAC des Basses Auges
1, rue Alfred de Vigny
78112 FOURQUEUX, FRANCE
Telephone: 33.1.3087.5300
Fax: 33.1.3087.5301

Document number: 600817-A
Published: 11 June 1999

Printed in the USA

Contents

1

Introduction

Overview 1-3

Intended Audience 1-3

Organization 1-3

Associated Documents 1-4

Explanation of Symbols and Notes 1-4

Assistance 1-5

2

Description

Overview 2-3

DAS Working Environment 2-4

Structure of the DAS Software 2-4

 DAS Client 2-4

 DAS Server 2-5

 Command Processing 2-6

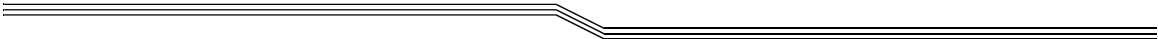

DAS Commands	2-6
Media Management	2-6
DAS Management	2-7
Client Management	2-7
Scratch Pool Management	2-7
DAS Functions	2-7
Communication with the ACI	2-8
Communication with the ACI Client	2-8
Configuration Management	2-8
Client Authorization	2-9
Command Verification	2-9
Error Handling	2-10
Mount and Dismount Media in the AML	2-10
Working with Foreign Media	2-10
Inserting Media in the AML	2-11
Ejecting Media from the AML	2-11
Scratch Pool Administration	2-11
HICAP Application	2-11
Dual AMU Support	2-12

3

Safety

Overview	3-3
Hazard Alert Messages	3-3
Validity	3-5

4

Installation and Configuration

Overview	4-3
Installing the DAS Software	4-3
Installation Using Dasinst.cmd	4-3
Installation Without the Install Program	4-5
Configuring the Server Software	4-7

Editing the Config.sys File	4-7
Editing the Startup.cmd File	4-8
Editing the Config File	4-9
Configuration File	4-10
Structure and Syntax of Config	4-10
Definition of Ranges	4-11
Definition of Volser Ranges	4-11
Options	4-12
Avoid Volume Contention Option	4-12
Dismount Option	4-12
The Client Statement	4-13
Syntax	4-13
The DriveToVol Statement	4-16
Syntax	4-16
The Server Statement	4-16
Syntax	4-16
Configuration File	4-18
DAS Configuration in AMS	4-20
Drives	4-20
I/O Unit	4-21
Scratchpools	4-23
Installing the ACI Software	4-24
UNIX-Client	4-24
Microsoft Windows NT Client Using RPC	4-25
Microsoft Windows NT Client Using RSH	4-26
Configuration DAS Client on the OS/2 PC 4-26	
Configuration Windows for the ACI Client	4-28
Configuration of the UNIX-Client Software	4-29
Example of the C Shell	4-29
Example of the Korn and Bourne Shell	4-29
DAS Environment Variables	4-30

5

DAS Commands

Overview	5-3
DAS Command Classifications	5-3
Client Management Commands	5-3

Media Management Commands	5-4
DAS Management Commands	5-5
Scratch Management Commands	5-6
Command Description	5-7
Change Drive Reservation (allocd)	5-7
Reserve Volsers (allocv)	5-8
Activate/Deactivate the Barcode Reader (barcode)	5-9
Cancel Commands (cancel)	5-10
Catalog Foreign Volume (catf)	5-10
Drive Cleaning (clean)	5-12
Retrieve a Medium from the Drive (dismount)	5-13
Eject Media (eject2)	5-14
Eject Media (eject)	5-16
Eject Cleaning Cartridges (ejectcl)	5-17
Flip Optical Disk in the Drive (flip)	5-18
Display Volser for Drive (getvolserdrive)	5-19
Assign Volsers to an Optical Disk (getvolserdrive)	5-20
Insert Media (insert2)	5-21
Insert Media (insert)	5-22
Compare Volsers in the AML (inventory)	5-23
Shut Down the AMU PC (killamu)	5-24
Display All Active Commands (list)	5-25
Display Drive Assignment	5-27
Listd3	5-27
Listd2	5-29
Listd	5-31
Display Volser Reservation (listv)	5-33
Load Cartridge in Drive (mount)	5-34
Compare Volser Ranges (PartInventory)	5-35
Query the Software Version (qversion)	5-36
Query the Volser Ranges in the AML (qvolserange)	5-36
Remove a Foreign Medium (rmf)	5-39
Deactivate Robotic Controller in the AML (robhome)	5-40
Activate Robotic Controller in the AML (robstat)	5-41
Set Access Privileges (scap)	5-42
Set Operating Parameters (scop)	5-43
Next Scratch Medium (scr_get)	5-44
Scratch Pool Information (scr_info)	5-45
Insert Scratch Media (scr_insert)	5-46
Execute Scratch Mount (scr_mount)	5-47
Add Media to the Scratch Pool (scr_set)	5-48
Remove Medium from Scratch Pool (scr_unset)	5-49
Display Client Parameters (show)	5-50
Shut Down DAS (shutdown)	5-52
Switch to the Passive AMU (switch)	5-52
Operate Drive Buttons (unload)	5-53
Obtain Information on a Volser (view)	5-54

DAS Messages

Overview	6-17
DAS Message Classification	6-17
DAS ACI Messages	6-17
DAS Server Messages to the ACI	6-17
Conventions in the Messages	6-18
DAS Server Messages	6-18
DAS0001	6-18
DAS ACI Message	6-18
Explanation	6-18
User Activities	6-18
DAS0002	6-19
DAS ACI Message	6-19
Explanation	6-19
User Activities	6-19
DAS0003	6-19
DAS ACI Message	6-19
Explanation	6-19
User Activities	6-19
DAS3000	6-20
DAS ACI Message	6-20
Explanation	6-20
User Activities	6-20
DAS3001	6-20
DAS ACI Message	6-20
Explanation	6-20
User Activities	6-20
DAS3002	6-21
DAS ACI Message	6-21
Explanation	6-21
User Activities	6-21
DAS3003	6-21
DAS ACI Message	6-21
Explanation	6-21
User Activities	6-21
DAS3004	6-22
DAS ACI Message	6-22
Explanation	6-22
User Activities	6-22
DAS3020	6-22
DAS ACI Message	6-22

Explanation	6-22
User Activities	6-22
DAS 3021	6-23
DAS ACI Message	6-23
Explanation	6-23
User Activities	6-23
DAS3022	6-23
DAS ACI Message	6-23
Explanation	6-23
User Activities	6-23
DAS3023	6-24
DAS ACI Message	6-24
Explanation	6-24
User Activities	6-24
DAS3500	6-24
DAS ACI Message	6-24
Explanation	6-24
User Activities	6-25
DAS3501	6-25
DAS ACI Message	6-25
Explanation	6-25
User Activities	6-25
DAS3502	6-25
DAS ACI Message	6-25
Explanation	6-25
User Activities	6-26
DAS3503	6-26
DAS ACI Message	6-26
Explanation	6-26
User Activities	6-26
DAS3504	6-26
DAS ACI Message	6-26
Explanation	6-26
User Activities	6-27
DAS4000	6-27
DAS ACI Message	6-27
Explanation	6-27
User Activities	6-27
DAS4001	6-27
DAS ACI Message	6-27
Explanation	6-28
User Activities	6-28
DAS4002	6-28
DAS ACI Message	6-28
Explanation	6-28
User Activities	6-28
DAS4003	6-29
DAS ACI Message	6-29
Explanation	6-29

User Activities	6-29
DAS4004	6-29
DAS ACI Message	6-29
Explanation	6-29
User Activities	6-30
DAS4005	6-30
DAS ACI Message	6-30
Explanation	6-30
User Activities	6-30
DAS4006	6-31
DAS ACI Message	6-31
Explanation	6-31
User Activities	6-31
DAS4007	6-31
DAS ACI Message	6-31
Explanation	6-31
User Activities	6-32
DAS4010	6-32
DAS ACI Message	6-32
Explanation	6-32
User Activities	6-32
DAS4011	6-33
DAS ACI Message	6-33
Explanation	6-33
User Activities	6-33
DAS4012	6-33
DAS ACI Message	6-33
Explanation	6-33
User Activities	6-34
DAS4013	6-34
DAS ACI Message	6-34
Explanation	6-34
User Activities	6-34
DAS4020	6-35
DAS ACI Message	6-35
Explanation	6-35
User Activities	6-35
DAS4021	6-35
DAS ACI Message	6-35
Explanation	6-35
User Activities	6-35
DAS4022	6-36
DAS ACI Message	6-36
Explanation	6-36
User Activities	6-36
DAS4023	6-36
DAS ACI Message	6-36
Explanation	6-36
User Activities	6-36

DAS4024	6-37
DAS ACI Message	6-37
Explanation	6-37
User Activities	6-37
DAS4030	6-38
DAS ACI Message	6-38
Explanation	6-38
User Activities	6-38
DAS4031	6-38
DAS ACI Message	6-38
Explanation	6-38
User Activities	6-38
DAS4032	6-39
DAS ACI Message	6-39
Explanation	6-39
User Activities	6-39
DAS4033	6-39
DAS ACI Message	6-39
Explanation	6-39
User Activities	6-40
DAS4040	6-40
DAS ACI Message	6-40
Explanation	6-40
User Activities	6-40
DAS4041	6-40
DAS ACI Message	6-40
Explanation	6-41
User Activities	6-41
DAS4042	6-41
DAS ACI Message	6-41
Explanation	6-41
User Activities	6-41
DAS4043	6-42
DAS ACI Message	6-42
Explanation	6-42
User Activities	6-42
DAS4044	6-42
DAS ACI Message	6-42
Explanation	6-42
User Activities	6-43
DAS4045	6-43
DAS ACI Message	6-43
Explanation	6-43
User Activities	6-43
DAS4050	6-44
DAS ACI Message	6-44
Explanation	6-44
User Activities	6-44
DAS4051	6-44

DAS ACI Message	6-44
Explanation	6-44
User Activities	6-44
DAS4052	6-45
DAS ACI Message	6-45
Explanation	6-45
User Activities	6-45
DAS4053	6-45
DAS ACI Message	6-45
Explanation	6-45
User Activities	6-45
DAS4054	6-46
DAS ACI Message	6-46
Explanation	6-46
User Activities	6-46
DAS4055	6-46
DAS ACI Message	6-46
Explanation	6-47
User Activities	6-47
DAS4056	6-47
DAS ACI Message	6-47
Explanation	6-47
User Activities	6-47
DAS4057	6-48
DAS ACI Message	6-48
Explanation	6-48
User Activities	6-48
DAS4060	6-48
DAS ACI Message	6-48
Explanation	6-48
User Activities	6-48
DAS4061	6-49
DAS ACI Message	6-49
Explanation	6-49
User Activities	6-49
DAS4062	6-49
DAS ACI Message	6-49
Explanation	6-49
User Activities	6-49
DAS4063	6-50
DAS ACI Message	6-50
Explanation	6-50
User Activities	6-50
DAS4064	6-50
DAS ACI Message	6-50
Explanation	6-50
User Activities	6-51
DAS4065	6-51
DAS ACI Message	6-51

Explanation	6-51
User Activities	6-51
DAS4066	6-51
DAS ACI Message	6-51
Explanation	6-51
User Activities	6-52
DAS4070	6-52
DAS ACI Message	6-52
Explanation	6-52
User Activities	6-52
DAS4071	6-52
DAS ACI Message	6-52
Explanation	6-53
User Activities	6-53
DAS4072	6-53
DAS ACI Message	6-53
Explanation	6-53
User Activities	6-53
DAS4080	6-53
DAS ACI Message	6-53
Explanation	6-54
User Activities	6-54
DAS4081	6-54
DAS ACI Message	6-54
Explanation	6-54
User Activities	6-54
DAS4082	6-54
DAS ACI Message	6-54
Explanation	6-54
User Activities	6-55
DAS4090	6-55
DAS ACI Message	6-55
Explanation	6-55
User Activities	6-55
DAS4091	6-55
DAS ACI Message	6-55
Explanation	6-55
User Activities	6-56
DAS4092	6-56
DAS ACI Message	6-56
Explanation	6-56
User Activities	6-56
DAS4093	6-56
DAS ACI Message	6-56
Explanation	6-57
User Activities	6-57
DAS4094	6-57
DAS ACI Message	6-57
Explanation	6-57

User Activities	6-57
DAS4095	6-58
DAS ACI Message	6-58
Explanation	6-58
User Activities	6-58
DAS4096	6-58
DAS ACI Message	6-58
Explanation	6-59
User Activities	6-59
DAS4100	6-59
DAS ACI Message	6-59
Explanation	6-59
User Activities	6-59
DAS4101	6-60
DAS ACI Message	6-60
Explanation	6-60
User Activities	6-60
DAS4102	6-60
DAS ACI Message	6-60
Explanation	6-60
User Activities	6-60
DAS4110	6-61
DAS ACI Message	6-61
Explanation	6-61
User Activities	6-61
DAS4111	6-61
DAS ACI Message	6-61
Explanation	6-61
User Activities	6-61
DAS4120	6-62
DAS ACI Message	6-62
Explanation	6-62
User Activities	6-62
DAS4121	6-62
DAS ACI Message	6-62
Explanation	6-62
User Activities	6-62
DAS4130	6-63
DAS ACI Message	6-63
Explanation	6-63
User Activities	6-63
DAS4131	6-63
DAS ACI Message	6-63
Explanation	6-63
User Activities	6-63
DAS4140	6-64
DAS ACI Message	6-64
Explanation	6-64
User Activities	6-64

DAS4141	6-64
DAS ACI Message	6-64
Explanation	6-64
User Activities	6-64
DAS4150	6-65
DAS ACI Message	6-65
Explanation	6-65
User Activities	6-65
DAS4151	6-65
DAS ACI Message	6-65
Explanation	6-65
User Activities	6-65
DAS4160	6-66
DAS ACI Message	6-66
Explanation	6-66
User Activities	6-66
DAS4161	6-66
DAS ACI Message	6-66
Explanation	6-66
User Activities	6-66
DAS4170	6-67
DAS ACI Message	6-67
Explanation	6-67
User Activities	6-67
DAS4171	6-67
DAS ACI Message	6-67
Explanation	6-67
User Activities	6-67
DAS4180	6-68
DAS ACI Message	6-68
Explanation	6-68
User Activities	6-68
DAS4181	6-68
DAS ACI Message	6-68
Explanation	6-68
User Activities	6-68
DAS4190	6-69
DAS ACI Message	6-69
Explanation	6-69
User Activities	6-69
DAS4191	6-69
DAS ACI Message	6-69
Explanation	6-69
User Activities	6-69
DAS4200	6-70
DAS ACI Message	6-70
Explanation	6-70
User Activities	6-70
DAS4201	6-70

DAS ACI Message	6-70
Explanation	6-70
User Activities	6-70
DAS4204	6-71
DAS ACI Message	6-71
Explanation	6-71
User Activities	6-71
DAS4205	6-71
DAS ACI Message	6-71
Explanation	6-71
User Activities	6-71
DAS4210	6-72
DAS ACI Message	6-72
Explanation	6-72
User Activities	6-72
DAS4211	6-72
DAS ACI Message	6-72
Explanation	6-72
User Activities	6-72
DAS4220	6-73
DAS ACI Message	6-73
Explanation	6-73
User Activities	6-73
DAS4221	6-74
DAS ACI Message	6-74
Explanation	6-74
User Activities	6-74
DAS4230	6-74
DAS ACI Message	6-74
Explanation	6-74
User Activities	6-74
DAS4231	6-75
DAS ACI Message	6-75
Explanation	6-75
User Activities	6-75
DAS4232	6-75
DAS ACI Message	6-75
Explanation	6-75
User Activities	6-75
DAS4240	6-76
DAS ACI Message	6-76
Explanation	6-76
User Activities	6-76
DAS4241	6-76
DAS ACI Message	6-76
Explanation	6-76
User Activities	6-77
DAS4242	6-77
DAS ACI Message	6-77

Explanation	6-77
User Activities	6-77
DAS4250	6-77
DAS ACI Message	6-77
Explanation	6-77
User Activities	6-78
DAS4251	6-78
DAS ACI Message	6-78
Explanation	6-78
User Activities	6-78
DAS4260	6-78
DAS ACI Message	6-78
Explanation	6-78
User Activities	6-78
DAS4261	6-79
DAS ACI Message	6-79
Explanation	6-79
User Activities	6-79
DAS4270	6-79
DAS ACI Message	6-79
Explanation	6-79
User Activities	6-79
DAS4271	6-80
DAS ACI Message	6-80
Explanation	6-80
User Activities	6-80
DAS4272	6-80
DAS ACI Message	6-80
Explanation	6-80
User Activities	6-80
DAS4280	6-81
DAS ACI Message	6-81
Explanation	6-81
User Activities	6-81
DAS4281	6-81
DAS ACI Message	6-81
Explanation	6-81
User Activities	6-81
DAS4282	6-82
DAS ACI Message	6-82
Explanation	6-82
User Activities	6-82
DAS4290	6-82
DAS ACI Message	6-82
Explanation	6-82
User Activities	6-83
DAS4291	6-83
DAS ACI Message	6-83
Explanation	6-83

User Activities	6-83
DAS4292	6-83
DAS ACI Message	6-83
Explanation	6-83
User Activities	6-83
DAS4293	6-84
DAS ACI Message	6-84
Explanation	6-84
User Activities	6-84
DAS4295	6-84
DAS ACI Message	6-84
Explanation	6-84
User Activities	6-85
DAS4296	6-86
DAS ACI Message	6-86
Explanation	6-86
User Activities	6-86
DAS4297	6-86
DAS ACI Message	6-86
Explanation	6-86
User Activities	6-87
DAS4300	6-87
Explanation	6-87
User Activities	6-87
DAS4301	6-87
DAS ACI Message	6-87
Explanation	6-87
User Activities	6-88
DAS4302	6-88
DAS ACI Message	6-88
Explanation	6-88
User Activities	6-88
DAS4400	6-88
Explanation	6-88
User Activities	6-88
DAS4401	6-89
DAS ACI Message	6-89
Explanation	6-89
User Activities	6-89
DAS4402	6-89
DAS ACI Message	6-89
Explanation	6-89
User Activities	6-89
DAS ACI Messages	6-90
ACI0001	6-90
Explanation	6-90
User Activities	6-90
ACI0002	6-90
Explanation	6-90

User Activities	6-90
ACI0003	6-91
Explanation	6-91
User Activities	6-91
ACI0004	6-91
Explanation	6-91
User Activities	6-91
ACI0005	6-92
Explanation	6-92
User Activities	6-92
ACI0006	6-92
Explanation	6-92
User Activities	6-92
ACI0007	6-93
Explanation	6-93
User Activities	6-93
ACI0008	6-93
Explanation	6-93
User Activities	6-93
ACI0009	6-93
Explanation	6-93
User Activities	6-93
ACI0010	6-94
Explanation	6-94
User Activities	6-94
ACI0011	6-94
Explanation	6-94
User Activities	6-94
ACI0012	6-94
Explanation	6-94
User Activities	6-94
ACI0013	6-95
Explanation	6-95
User Activities	6-95
ACI0014	6-95
Explanation	6-95
User Activities	6-95
ACI0015	6-95
Explanation	6-95
User Activities	6-95
ACI0020	6-96
Explanation	6-96
User Activities	6-96
ACI0021	6-96
Explanation	6-96
User Activities	6-96
ACI0022	6-97
Explanation	6-97
User Activities	6-97

ACI0023	6-97
Explanation	6-97
User Activities	6-97
ACI0024	6-98
Explanation	6-98
User Activities	6-98
Derrno Variable	6-99
0 - EOK	6-99
Explanation	6-99
User Activities	6-99
1 - ERPC	6-99
Explanation	6-99
User Activities	6-99
2 - EINVAL	6-100
Explanation	6-100
User Activities	6-100
3 - ENOVOLUME	6-100
Explanation	6-100
User Activities	6-100
4 - ENODRIVE	6-101
Explanation	6-101
User Activities	6-101
5 - EDRVOCCUPIED	6-101
Explanation	6-101
User Activities	6-101
6 - EPROBVOL	6-102
Explanation	6-102
User Activities	6-102
7 - EAMU	6-102
Explanation	6-102
User Activities	6-102
8 - EAMUCOMM	6-103
Explanation	6-103
User Activities	6-103
9 - EROBOT	6-103
Explanation	6-103
User Activities	6-103
10 - EROBOTCOMM	6-104
Explanation	6-104
User Activities	6-104
11 - ENODAS	6-104
Explanation	6-104
User Activities	6-104
12 - EDEVEMPTY	6-105
Explanation	6-105
User Activities	6-105
13 - ENOTREG	6-105
Explanation	6-105
User Activities	6-105

14 - EBADHOST	6-106
Explanation	6-106
User Activities	6-106
15 - ENOAREA	6-106
Explanation	6-106
User Activities	6-106
16 - ENOTAUTH	6-107
Explanation	6-107
User Activities	6-107
17 - EDYNFULL	6-107
Explanation	6-107
User Activities	6-107
18 - EUPELSE	6-108
Explanation	6-108
User Activities	6-108
19 - EBADCLIENT	6-108
Explanation	6-108
User Activities	6-108
20 - EBADDYN	6-109
Explanation	6-109
User Activities	6-109
21 - ENOREQ	6-109
Explanation	6-109
User Activities	6-109
22 - ERETRYL	6-110
Explanation	6-110
User Activities	6-110
23 - ENOTMOUNTED	6-110
Explanation	6-110
User Activities	6-110
24 - EINUSE	6-111
Explanation	6-111
User Activities	6-111
25 - ENOSPACE	6-111
Explanation	6-111
User Activities	6-111
26 - ENOTFOUND	6-112
Explanation	6-112
User Activities	6-112
27 - ECANCELLED	6-112
Explanation	6-112
User Activities	6-112
28 - EDASIN	6-113
Explanation	6-113
User Activities	6-113
29 - EACIINT	6-113
Explanation	6-113
User Activities	6-113
30 - EMOREDATA	6-114

	Explanation	6-114
	User Activities	6-114
31 - ENOMATCH		6-114
	Explanation	6-114
	User Activities	6-114
32 - EOTHERPOOL		6-115
	Explanation	6-115
	User Activities	6-115
33 - ECLEANING		6-115
	Explanation	6-115
	User Activities	6-115
34 - ETIMEOUT		6-116
	Explanation	6-116
	User Activities	6-116
35 - ESWITCHINPROG		6-116
	Explanation	6-116
	User Activities	6-116
36 - ENOPOOL		6-117
	Explanation	6-117
	User Activities	6-117
37 - EAREAFULL		6-117
	Explanation	6-117
	User Activities	6-117
38 - EHICAPINUSE		6-118
	Explanation	6-118
	User Activities	6-118
39 - ENODOUBLESIDE		6-118
	Explanation	6-118
	User Activities	6-118
40- EEXUP		6-118
	Explanation	6-118
	User Activities	6-118
41- EPROBDEV		6-119
	Explanation	6-119
	User Activities	6-119
42- ECOORDINATE		6-119
	Explanation	6-119
	User Activities	6-119
43- EAREAEMPTY		6-119
	User Activities	6-119
44- EBARCODE		6-119
	Explanation	6-120
	User Activities	6-120
45 - EUPDOWN		6-120
	Explanation	6-120
	User Activities	6-120
46 - ENOTSUPPHCMD		6-120
	Explanation	6-120
	User Activities	6-120

47 - EDATABASE	6-120
Explanation	6-120
User Activities	6-121
48 - ENOROBOT	6-121
Explanation	6-121
User Activities	6-121
49 - EINVALIDDEV	6-121
Explanation	6-121
User Activities	6-121
50 - NO_ECODES	6-121
Explanation	6-121
User Activities	6-121

7

Utilities

Overview	7-3
RPC Test (TCP/IP Function)	7-3
DAS Wait Program	7-3
Startup.smp	7-4
DB/2 query tools	7-4
CNT2ZERO.CMD	7-4
SHOWPOOL.CMD	7-5
SHOWSCRATCH.CMD	7-5
SHOWVOLSER.CMD	7-5

8

Communication Applications

Overview	8-3
ADSM VirOp	8-3
Installation	8-3
Setup	8-5
Install Option	8-5
Configure Drives	8-5
Configure Libraries	8-6

Update Drive Config	8-7
Update Library Config	8-7
ADSM Configuration	8-7
Scratch Handling	8-8
Required DAS Configuration	8-8
DRM Support	8-9
Shell Scripts	8-9
Label Script	8-12
Using EMM commands without ADSM	8-12
ARCserve VirOp for Novell	8-14
Concept	8-14
Schematic Structure of the Work Environment	8-14
Backup	8-15
Restore	8-16
Design	8-16
Object Diagram	8-16
ArcVirOp	8-18
ConfigMgr	8-18
MediaListMgr	8-18
DriveListMgr	8-18
JobListMgr	8-18
ARCObserver	8-19
DASAdaptor	8-19
Ctrace	8-19
Installation	8-19
Installation Files	8-19
Installation Procedure	8-20
Configuration	8-20
Configuration Parameters	8-20
Example File ArcVirOp.cfg	8-23
Example File Medialist.txt	8-25
Example File Drivelist.txt	8-25
Example File Config of the DAServer on the AMU Controller (OS/2 Computer)	
8-25	8-25
Start-up	8-26
Sequence of Operations	8-26
Error, Warnings and Information	8-26
Message Construction	8-26
Messages	8-27
NETWORKER NT	8-33
Installation	8-33
Configuration	8-33

A

Application Notes

Overview	A-3
Notes on the Applications	A-3
Omniback	A-3
Directory Path and Link	A-3
Environment Variables	A-4
Drives	A-4
Logical Ranges of the I/O unit	A-5
Networker	A-6
ArcServ for Novell	A-6
Windows-Clients (Remote Shell)	A-6
Media Types	A-7
DAS Configuration Datasheet	A-9

Index

Figures

Figure 2-1	UNIX and MVS with Shared AML	2-3
Figure 2-2	DAS Structure	2-4
Figure 2-3	Modules in the DAS	2-5
Figure 2-4	Assignment of Symbolic Volsers for Foreign Media	2-11
Figure 2-5	Structure of Dual AMU Support	2-13
Figure 4-1	Command to Stop DAS	4-3
Figure 4-2	Command to Install DAS	4-4
Figure 4-3	DAS Installation Utility Menu	4-4
Figure 4-4	Accepting DUAL DAS Installation	4-4
Figure 4-5	Entering Hostname	4-4
Figure 4-6	Entering IP Address	4-5
Figure 4-7	Command to Make the DAS Directory	4-5
Figure 4-8	Command to Change to the DAS Directory	4-5
Figure 4-9	Command to Copy the Floppy	4-6
Figure 4-10	Command to Unzip the DAS Software	4-6
Figure 4-11	Command to Edit the Config.sys File	4-7
Figure 4-12	Modifying the Config.sys File	4-7
Figure 4-13	Command to Edit the Startup.cmd File	4-8
Figure 4-14	Modifying the Startup.cmd File	4-8
Figure 4-15	Command to Copy the Config.smp File	4-9
Figure 4-16	Command to Edit Config	4-9
Figure 4-17	Example of Config File Entries	4-10

Figure 4-18	Example of Comment Lines	4-10
Figure 4-19	Assigning Device	4-11
Figure 4-20	Client Statement	4-13
Figure 4-21	DriveToVol Statement	4-16
Figure 4-22	Server Statement	4-17
Figure 4-23	Example of the Configuration File	4-19
Figure 4-24	Graphical Configuration Window	4-20
Figure 4-25	AMS-DAS Configuration for Drives	4-21
Figure 4-26	EIF-Configuration Window	4-21
Figure 4-27	AMS-DAS Configuration for EIF Ranges	4-22
Figure 4-28	Scratchpool Configuration	4-23
Figure 4-29	Command to Make Directories	4-24
Figure 4-30	FTP Copy of ACI Software	4-24
Figure 4-31	Example of TAR Compression	4-25
Figure 4-32	Command to Copy ACI Software	4-26
Figure 4-33	Command to Edit the Config File	4-26
Figure 4-34	Adding a New Client	4-27
Figure 4-35	Setting Variables	4-28
Figure 4-36	Setting Environmental Variables	4-29
Figure 4-37	Setting Variables	4-30
Figure 5-1	Syntax of a Generic Allocd Command	5-7
Figure 5-2	Syntax of a Generic Allocv Command	5-8
Figure 5-3	Example of the Allocv Command	5-9
Figure 5-4	Syntax of a Generic Barcode Command	5-9
Figure 5-5	Example of the Barcode Command	5-9
Figure 5-6	Syntax of a Generic Cancel Commands	5-10
Figure 5-7	Example of the Cancel Command	5-10
Figure 5-8	Syntax of a Generic Catf Command	5-10
Figure 5-9	Example of the Catf Command	5-11
Figure 5-10	Syntax of a Generic Clean Command	5-12
Figure 5-11	Example of the Clean Command	5-12
Figure 5-12	Syntax of a Generic Dismount Command	5-13
Figure 5-13	Example of the Dismount Command	5-13

Figure 5-14	Syntax of a Generic Eject2 Command	5-14
Figure 5-15	Example of the Eject2 Command	5-15
Figure 5-16	Syntax of a Generic Eject Command	5-16
Figure 5-17	Example of the Eject Command	5-17
Figure 5-18	Syntax of a Generic Ejectcl Command	5-17
Figure 5-19	Example of the Ejectcl command	5-18
Figure 5-20	Syntax of a Generic Flip Command	5-18
Figure 5-21	Example of the Flip Command	5-18
Figure 5-22	Syntax of Generic Getvolsertodrive Command	5-19
Figure 5-23	Example of the Getvolsertodrive.	5-19
Figure 5-24	Syntax of a Generic Getvoltside Command	5-20
Figure 5-25	Example of the Getvoltside Command	5-20
Figure 5-26	Syntax of a Generic Insert2 Command.	5-21
Figure 5-27	Example of the Insert2 Command	5-22
Figure 5-28	Syntax of a Generic Insert Command.	5-22
Figure 5-29	Syntax of a Generic Inventory command.	5-23
Figure 5-30	Syntax of the Killamu Command	5-24
Figure 5-31	Syntax of a Generic a List Command	5-25
Figure 5-32	Example of the List Command	5-25
Figure 5-33	Syntax of a Generic Listd3 Command	5-27
Figure 5-34	Example of the Listd3 Command	5-28
Figure 5-35	Syntax of a Generic Listd2 Command.	5-29
Figure 5-36	Example of the Listd2 Command	5-30
Figure 5-37	Syntax of a Generic Listd Command	5-31
Figure 5-38	Example of the Listd Command	5-32
Figure 5-39	Syntax of a Generic Listv Command	5-33
Figure 5-40	Example of the Listv Command	5-33
Figure 5-41	Syntax of a Generic Mount Command.	5-34
Figure 5-42	Example of the Mount Command.	5-34
Figure 5-43	Syntax of a Generic PartInventory Command	5-35
Figure 5-44	Example of the PartInventory Command	5-35
Figure 5-45	Example of a Generic qversion Command	5-36
Figure 5-46	Example of the qversion Command	5-36

Figure 5-47	Syntax of a Generic qvolsrange Command	5-36
Figure 5-48	Example of the qvolsrange Command	5-37
Figure 5-49	Example of Return Status	5-37
Figure 5-50	Selection of Volsers Displayed	5-39
Figure 5-51	Syntax of a Generic Rmf Command	5-39
Figure 5-52	Example of the Rmf Command	5-40
Figure 5-53	Syntax of a Generic Robhome Command	5-40
Figure 5-54	Example of the Robhome Command	5-40
Figure 5-55	Syntax of a Generic Robstat Command	5-41
Figure 5-56	Example of the Robstat Command	5-41
Figure 5-57	Example of Return Status	5-41
Figure 5-58	Syntax of a Generic Scap Command	5-42
Figure 5-59	Example of the Scap Command	5-43
Figure 5-60	Syntax of a Generic Scop Command	5-43
Figure 5-61	Example of the Scop Command	5-44
Figure 5-62	Syntax of a Generic Scr_get Command	5-44
Figure 5-63	Example of the Scr_get command	5-44
Figure 5-64	Syntax of a Generic Scr_info Command	5-45
Figure 5-65	Example of the Scr_info Command	5-45
Figure 5-66	Syntax of a Generic Scr_insert Command	5-46
Figure 5-67	Example of the Scr_insert Command	5-46
Figure 5-68	Syntax of a Generic Scr-mount Command	5-47
Figure 5-69	Example of the Scr_mount Command	5-47
Figure 5-70	Syntax of a Generic Scr_set Command	5-48
Figure 5-71	Example of the Scr_set Command	5-49
Figure 5-72	Syntax of a Generic Scr_unset Command	5-49
Figure 5-73	Syntax of a Generic Show Command	5-50
Figure 5-74	Example of the Show Command with the -op Option	5-50
Figure 5-75	Example of the Show Command with the -ac Option	5-51
Figure 5-76	Syntax of a Generic Shutdown Command	5-52
Figure 5-77	Syntax of a Generic Switch Command	5-52
Figure 5-78	Syntax of a Generic Unload Command	5-53
Figure 5-79	Example of the Unload Command	5-54

Figure 5-80	Syntax of a Generic View Command	5-54
Figure 5-81	Example of Return Status	5-54
Figure 7-1	Example of the Rpcinfo Command	7-3
Figure 7-2	Example of a Response to the Rpcinfo Command	7-3
Figure 7-3	Example of the Os2sleep Command	7-4
Figure 7-4	Example of the Showscratch Command	7-5
Figure 7-5	Example of the Showvolser Command	7-5
Figure 8-1	Schematic Structure of the Work Environment	8-15
Figure 8-2	ArcVirOp Objects	8-17
Figure 8-3	Example of ArcVirOp.cfg File	8-24
Figure 8-4	Example of Error, Warning and Information Messages	8-32
Figure A-1	Variable Definition	A-4
Figure A-2	Omniback Jukebox Configuration Window	A-5
Figure A-3	Example of Logical Ranges	A-5
Figure A-4	Networker Jukebox Configuration	A-6

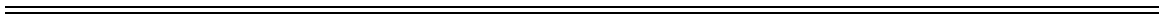

Tables

Table 3-1	Hazard Alert Message	3-3
Table 4-1	Client Statement.....	4-13
Table 4-2	Drive to Volser Range.....	4-16
Table 4-3	Optional Parameters	4-17
Table 4-4	Variables.....	4-28
Table 4-5	Environment Variable for DAS.....	4-30
Table 5-1	Client Management Commands	5-3
Table 5-2	Media Management Commands.....	5-4
Table 5-3	DAS Management Commands	5-5
Table 5-4	Scratch Management Commands	5-6
Table 5-5	Parameters for the Allocd Command.....	5-7
Table 5-6	Parameters for the Allocv Command.....	5-8
Table 5-7	Parameters for the Barcode Command	5-9
Table 5-8	Parameter for the Cancel Command	5-10
Table 5-9	Parameters for the Catf Command	5-11
Table 5-10	Parameter for the Clean Command	5-12
Table 5-11	Parameters for the Dismount Command.....	5-13
Table 5-12	Parameters for the Eject2 Command	5-14
Table 5-13	Explanation of the Returned Status	5-15
Table 5-14	Parameters for the Eject Command	5-16
Table 5-15	Parameters for the Eject Command	5-17
Table 5-16	Parameters for the Flip Command	5-18

Table 5-17	Parameters for the Getvolsertodrive Command	5-19
Table 5-18	Parameter for the Getvoltoside Command	5-20
Table 5-19	Parameters for the Insert Command	5-21
Table 5-20	Parameter for the Insert Command	5-22
Table 5-21	Parameters for the List Command	5-25
Table 5-22	Explanation of Returned Status.	5-26
Table 5-23	Parameter for the Listd3 Command	5-27
Table 5-24	Explanation of Return Status.	5-28
Table 5-25	Parameter for the Listd2 Command	5-30
Table 5-26	Explanation of Returned Status.	5-30
Table 5-27	Parameter for the Listd Command	5-31
Table 5-28	Explanation of the Return Status.	5-32
Table 5-29	Parameter for the Listv Command	5-33
Table 5-30	Parameters for the Mount Command.	5-34
Table 5-31	Parameters for the PartInventory Command	5-35
Table 5-32	Parameters for the qvolsrange Command	5-37
Table 5-33	Explanation of Return Status.	5-38
Table 5-34	Parameters for the Rmf Command	5-39
Table 5-35	Parameter for the Robhome Command	5-40
Table 5-36	Parameters for the Robstat Command	5-41
Table 5-37	Parameters for the Scap Command	5-42
Table 5-38	Parameters for the Scop Command	5-43
Table 5-39	Parameters for the Scr_get Command	5-44
Table 5-40	Parameters for the Scr_info Command	5-45
Table 5-41	Parameters for the Scr_insert Command	5-46
Table 5-42	Parameters for the Scr_mount Command	5-47
Table 5-43	Parameters for the Scr_set Command	5-48
Table 5-44	Parameters for the Scr_unset Command	5-49
Table 5-45	Options for the Show Command	5-50
Table 5-46	Parameters for the Show Command.	5-51
Table 5-47	Parameter for the Shutdown Command	5-52
Table 5-48	Parameters for the Switch Command.	5-53
Table 5-49	Parameter for the Unload Command.	5-53

Table 5-50	Parameters for the View Command	5-54
Table 5-51	Explanation of Return Status	5-55
Table 5-52	Parameter for the Os2sleep Command	7-4
Table 8-1	Software Release to Platform Requirements	8-3
Table 8-2	Parameters for the Configuration File	8-20
Table A-1	Links Required for Omniback with DAS	A-3
Table A-2	Pathname by OS Version	A-4
Table A-3	Pathname by OS Version	A-5
Table A-4	List of Supported Media Types	A-7

1

Introduction

Overview	1-3
Intended Audience	1-3
Organization	1-3
Associated Documents	1-4
Explanation of Symbols and Notes	1-4
Assistance	1-5

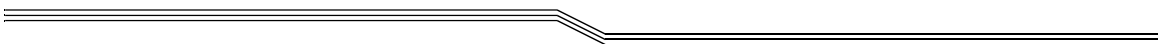

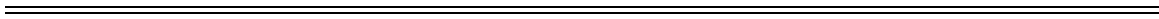

Overview

This document contains the information and instructions necessary to set up and operate the Distributed AML Server (DAS) software for version 3.0 and higher. The topics discussed in this chapter are:

- Overview
- Intended Audience
- Organization
- Associated Documents
- Explanation of Symbols and Notes
- Assistance

Intended Audience

The document is intended for system administrators and operators working with the DAS software, version 3.0 and higher. Knowledge of the UNIX and OS/2 operating systems is required.

Organization

The manual is divided into the following chapters:

Chapter 1	Introduction - Notes on the use of the manual
Chapter 2	Description - Overview of the functions on the DAS
Chapter 3	Safety - Information on the safe operation of the DAS
Chapter 4	Installation and Configuration - Explanation of the tasks necessary for installation and configuration
Chapter 5	DAS Commands - Alphabetic list of all administrator commands
Chapter 6	Messages - List of all messages and the relevant actions necessary
Chapter 7	Utilities - Description of further utilities for working with the DAS

Associated Documents

600816-A	DAS Interfacing Guide for Windows 95/ NT
600815-A	DAS Interfacing Guide

Explanation of Symbols and Notes

The following symbols and highlighted passages note important information.



Detailed explanations for the above symbols are provided in *Hazard Alert Messages* on page 3-3.

<1>+<2> Press these keys simultaneously.

Italic Headline, e.g., Chapter 3, *Safety*
File name, e.g., *dasdata.ini*

Bold Terms appearing on the operating panel
Special Term, e.g., Utilities
Commands with or without parameters,
e.g., **INITIALIZE**

Courier Command appearing on a console, e.g., `cd`
Switch position, e.g., ON, OFF



Assistance

If problems cannot be solved with the aid of this document or if recommended training is desired, contact the ADIC Technical Assistance Center (ATAC).

ADIC
10949 East Peakview Avenue
Englewood, CO 80112
U.S.A.

- United States 1-800-827-3822
- Europe and Africa 00-800-9999-3822



2

Description

Overview	2-3
DAS Working Environment	2-4
Structure of the DAS Software	2-4
DAS Client	2-4
DAS Server	2-5
Command Processing	2-6
DAS Commands	2-6
Media Management	2-6
DAS Management	2-7
Client Management	2-7
Scratch Pool Management	2-7
DAS Functions	2-7
Communication with the ACI	2-8
Communication with the ACI Client	2-8
Configuration Management	2-8
Client Authorization	2-9
Command Verification	2-9
Error Handling	2-10
Mount and Dismount Media in the AML	2-10
Working with Foreign Media	2-10
Inserting Media in the AML	2-11
Ejecting Media from the AML	2-11
Scratch Pool Administration	2-11
HICAP Application	2-11
Dual AMU Support	2-12

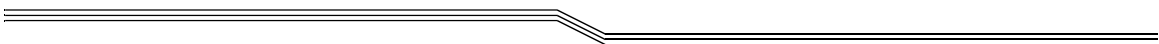

Overview

The following sections provide an introduction to the DAS environment, structure, administrative commands, and functions. See Figure 2-1.

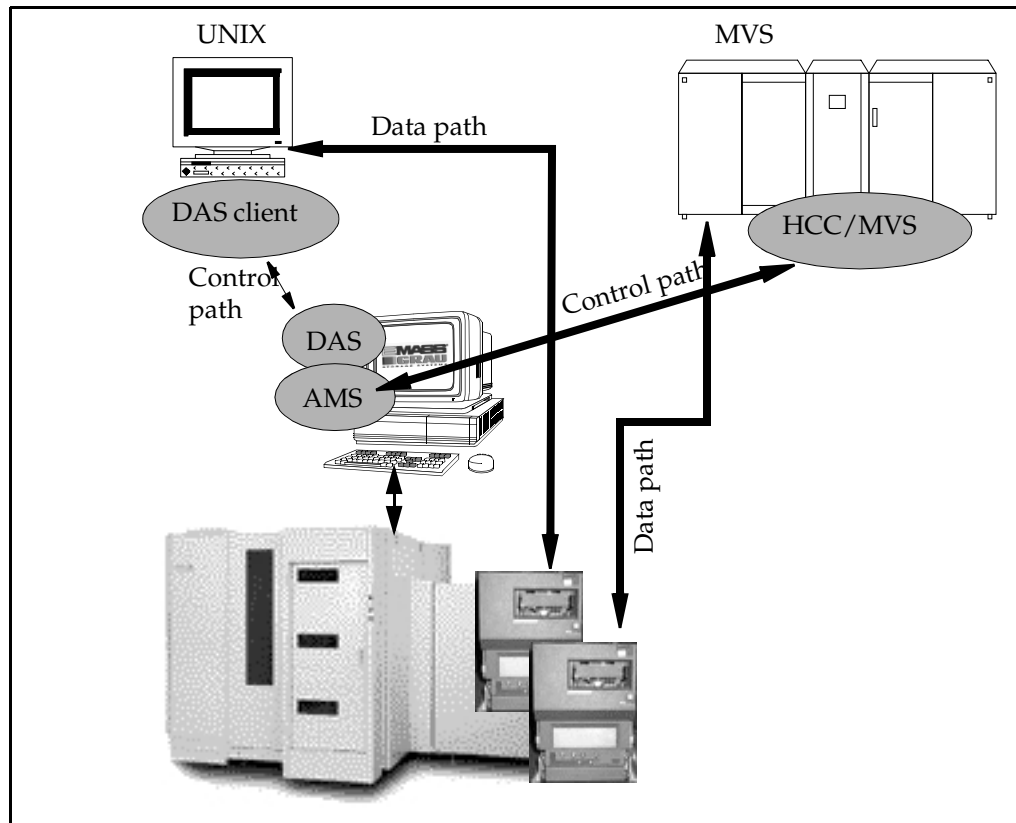

Figure 2-1 UNIX and MVS with Shared AML

The DAS software is a client/server software product designed to provide shared access to an ADIC/GRAU Storage Systems AML system by up to 50 separate clients. This means that the clients can run on entirely separate platforms while using various media in the AML system. The DAS software makes it possible for backup, document management or HSM applications to have direct access to the media in the ADIC/GRAU Storage Systems AML systems.

DAS Working Environment

The AML system is controlled by the AML Management Unit (control path). The data from the applications is sent directly to the drives independently of this (data path). The DAS software supports a wide variety of UNIX systems, and also the BS2000 and Windows NT. Connection to other operating systems such as MVS, VM or Tandem is made across another interface of the AMU.

Structure of the DAS Software

The DAS software comprise two main components:

- Server function
- ACI function (AML client interface)

DAS Client

The client software consists of a library of functions and an administration program (*dasadmin*). The software is available for various platforms. A new client simply requires the standard TCP/IP functions with ONC RPC (Remote Procedure Calls) support and an ANSI C compiler. The applications access the open interface (ACI). See Figure 2-2.

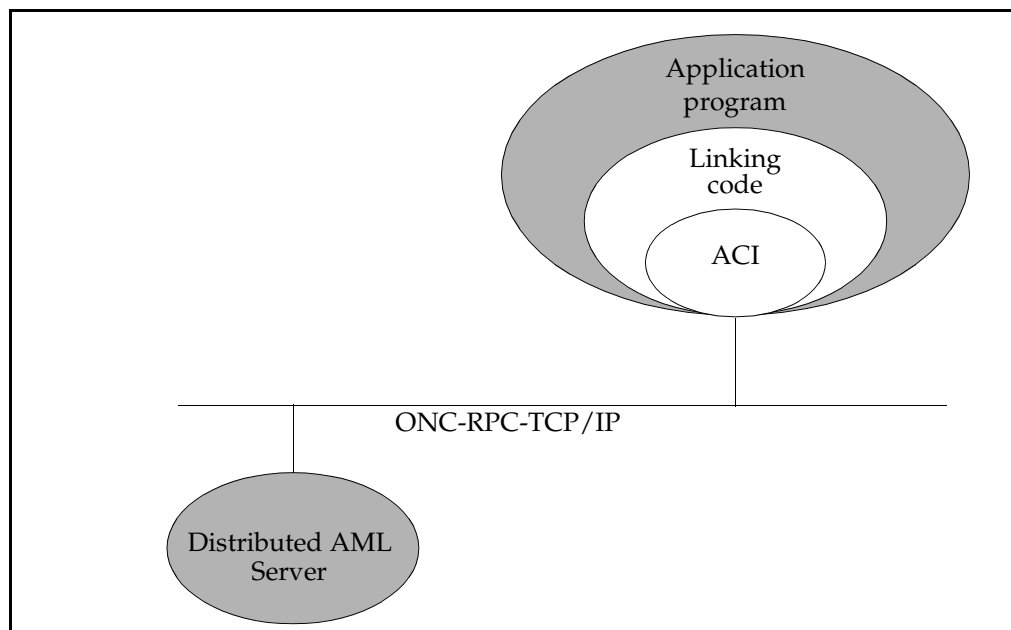

Figure 2-2 DAS Structure

Each client can be assigned specific access privileges to the AML.

- Functions (basic functions or all functions)
- Drives
- Volsers (Volume Serial Number)
- Ranges of the I/O units
- Scratch pools

DAS Server

The server software is installed on the AMU, which is a computer running OS/2. See Figure 2-3.

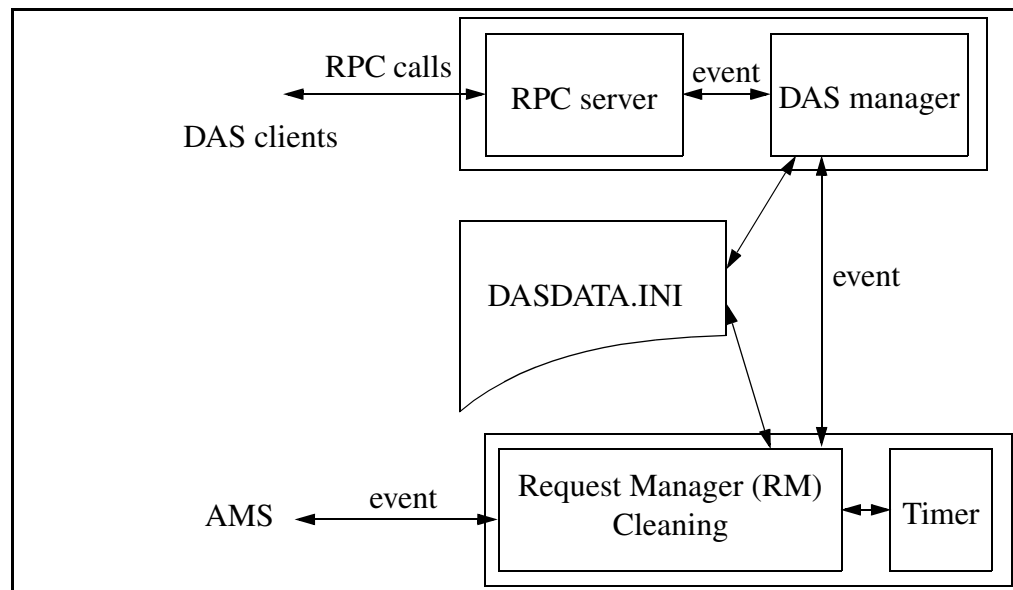

Figure 2-3 Modules in the DAS

The DAS server software is divided into three parts:

- RPC server
- DAS manager
- Request Manager.

The RPC server is responsible for communicating with the clients on the TCP/IP network and converts the requests and responses into the appropriate format.

The DAS manager controls access privileges and priorities and sends the authorized requests to the Request Manager.

The Request Manager sets up the AMS commands and sends these commands to the AML Management Software (AMS).

The *dasdata.ini* file is used to save information about drive allocation, volser allocation and foreign assignment.

Command Processing

The following is a simplified representation of one possible sequence of commands:

- The application reserves a drive in the DAS for a mount.
- The application requests a medium from a daemon for this mount.
- The daemon generates the mount request for the medium and sends it together with drive, media type and volser through the ACI to the DAS.
- DAS generates a mount command for the AMS
- The AMS acknowledges the procedure to the DAS on conclusion of the process.
- DAS passes the response on to the calling daemon
- The application writes data to, or reads data from, the medium.
- The application requests the daemon to unload the drive if this is successful.
- The daemon sends the unload command to the drive, and the dismount command to the DAS through the ACI.
- DAS executes the command through the AMS and sends an acknowledgment to the daemon

DAS Commands

DAS administrator commands can be divided into four areas:

- Media management
- DAS management
- Client management
- Scratch pool management

Media Management

- Mount and dismount
- Change sides on the optical disk in the drive
- Insert and eject
- Inventory
- View the available media
- View the media status

-
-
- Catalog or remove foreign media
 - Clean the drive
 - Insert and eject the cleaning cartridge

DAS Management

- Delete command
- View outstanding commands
- Activate and deactivate barcode reading for mount, move and eject from DAS
- Shut down DAS
- Shut down AMU

Client Management

- Reserve/release a drive for a client
- Reserve/release a volser for a client
- Modify access privileges for client
- Modify execution parameters

Scratch Pool Management

- Add volser to the scratch pool
- Remove volser from the scratch pool
- Get volser from the scratch pool
- View scratch pool information

DAS Functions

The DAS Software passes on all permitted Distributed AML client requests to the AML Management Software and facilitates AML system administration by means of the `dasadmin` program and the configuration file `config`. In detail, the following individual operations are executed on DAS:

- Communication with the ACI
- Communication with the AMS
- Configuration Management
- Client Authorization
- Command verification
- Error handling
- Mount and dismount media in the AML

-
-
- Work with foreign media
 - Insert media in the AML
 - Eject media from the AML
 - HICAP support
 - Scratch pool management
 - Support of the dual AMU
 - Services for drive cleaning

Communication with the A

The AML Client and the DAS software communicate using ONC RPC. Data is interpreted identically on all platforms through XDR data conversion protocol.

There may be a delay between the command being sent to the AML system and full acknowledgment (from a few seconds to a few minutes if the drives are busy at the time or if the AMS command queue is full). For this reason, the RPC calls are setup so that the DAS calls the relevant client back when the command has been completed. The RPC request is organized by the TCP/IP **Portmapper**.

Communication with the ACI Client

Communication with the ACI is implemented using the OS/2 **Event** mechanism. Compliance with the response time following a command call is monitored by a timer. A command is timed out or repeated if the command is not executed within the prescribed time.

The client is notified immediately when a command has been successfully completed. A decision is made whether it is worth repeating the command or an appropriate error message should be sent to the client, if an error occurs. The client will be notified if DAS error handling is unsuccessful. An exception is made for an inventory command which requires a large amount of time. This command will always be acknowledged immediately and the client will receive no further feedback following a positive or negative conclusion.

Configuration Management

ADIC/GRAU Storage Systems AML systems can be configured with a wide variety of storage systems, drives and I/O units. This information is stored in the AMS in a configuration file (Refer to the *AMU Reference Manual*).

The DAS software can access the AMS configuration data to get media and system information.

In addition to this configuration data which is loaded from the file *config* when the program is started, DAS requires further parameters of its own. These parameters are:

- Parameters for each client
 - Operating parameters
 - Access privileges for
 - drives
 - volser
 - I/O units
 - scratch pool
- Assignment of drives to volsers
- DAS Server statement

Client Authorization

Each client that has access to the DAS software must be authorized for the command. Authorization is implemented by:

- Comparison of the client name with the sender's TCP/IP address (assignment in the config file is by TCP/IP address or host name)
- Granting access privileges (complete or restricted)
- Assignment of privileges for devices (drives, volsers, I/O units, scratch pools)



The potential to limit access to media, drives and I/O units allows secure use of different applications on one AML system

Command Verification

Client requests are checked for:

- Command format and command syntax
- Parameter validity (drive, volser, I/O range etc.)

Error Handling

All client requests are buffered in DAS so that in the event of a communication error, the command can be resumed without loss of data, therefore avoiding unnecessary error handling measures. As soon as a client request is received by the DAS software:

- Command buffered (in RAM; this information is lost if there is a mains outage)
- Command to the dual AMU relayed to the dual DAS (if dual AMU is installed)
- Receipt confirmation sent to the client
- Command written to the AMS log file
- Command passed on to the AMS
- Response from AMS awaited for the preset time
- Client informed about the request status

The status of the drives and the cataloged foreign media are stored in the system file *dasdata.ini*.

Mount and Dismount Media in the AML

Mount and dismount are the basic AML functions for selecting the media from the archive using volsers, inserting the medium in the drives and returning it to the archive after use.

Working with Foreign Media

There is no need to mount media which are to be inserted in a drive in the AML only once and for a short time; instead such media can be introduced directly from the I/O unit into the drive as foreign media even without a barcode label. This means that media which already have an existing volser in the archive can be handled.

The areas in the I/O, which can be used for foreign media unit, must be defined in the AMS configuration.

A symbolic volser can be assigned a coordinate using the *catf* command (Refer to the *AMU Reference Manual*); this can then be used to perform a mount. See Figure 2-4.

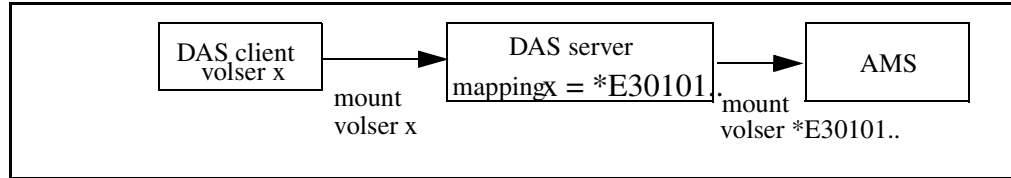

Figure 2-4 Assignment of Symbolic Volsers for Foreign Media

Inserting Media in the AML

The insert function through the I/O unit of the AML system can be used if new media is required in the AML (scratch media or for replacing seldom-used media). The DAS server allows clients with full access privileges (administrator) to insert media.

Ejecting Media from the AML

The eject function can be used through the I/O unit of the AML system to eject media which is no longer needed or not needed at present. The slot in the archive is retained for the volser if ejection is temporary, otherwise “Null volser” is entered and the slot becomes available for other volsers.

Scratch Pool Administration

DAS supports the creation of scratch pools to administrate media which are released for rewriting. The administrator can use the scratch pools to assign the media to be used to the individual applications. DAS supports

- The addition of volsers to a scratch pool
- The removal of volsers from the scratch pool
- Mounting a scratch medium from a scratch pool
- The output of the volser for the next available scratch medium
- The output of information to the scratch pool

HICAP Application

The large I/O unit of the AML/J system is known as HICAP (High Capacity). This I/O unit has the unusual feature that the archive is open while media are added and the robotic controller in the archive is shut down for safety reasons.

The request to open the HICAP is sent from the AMS to the DAS software. DAS reacts to this as follows:

- All new commands from clients which require the robotic controller are rejected with the EHICAPINUSE message.
- Commands remain in the queue; the timer sets longer time-outs for these commands.

The commands from the queue are processed when the AML/J system is available. The clients are not informed of this new status.

Dual AMU Support

Important components can be implemented redundantly to give increased protection against breakdown of the total ADIC/GRAU Storage Systems AML system. Including a second PC (dual AMU) brings the dual function of the DAS into operation. See Figure 2-5.

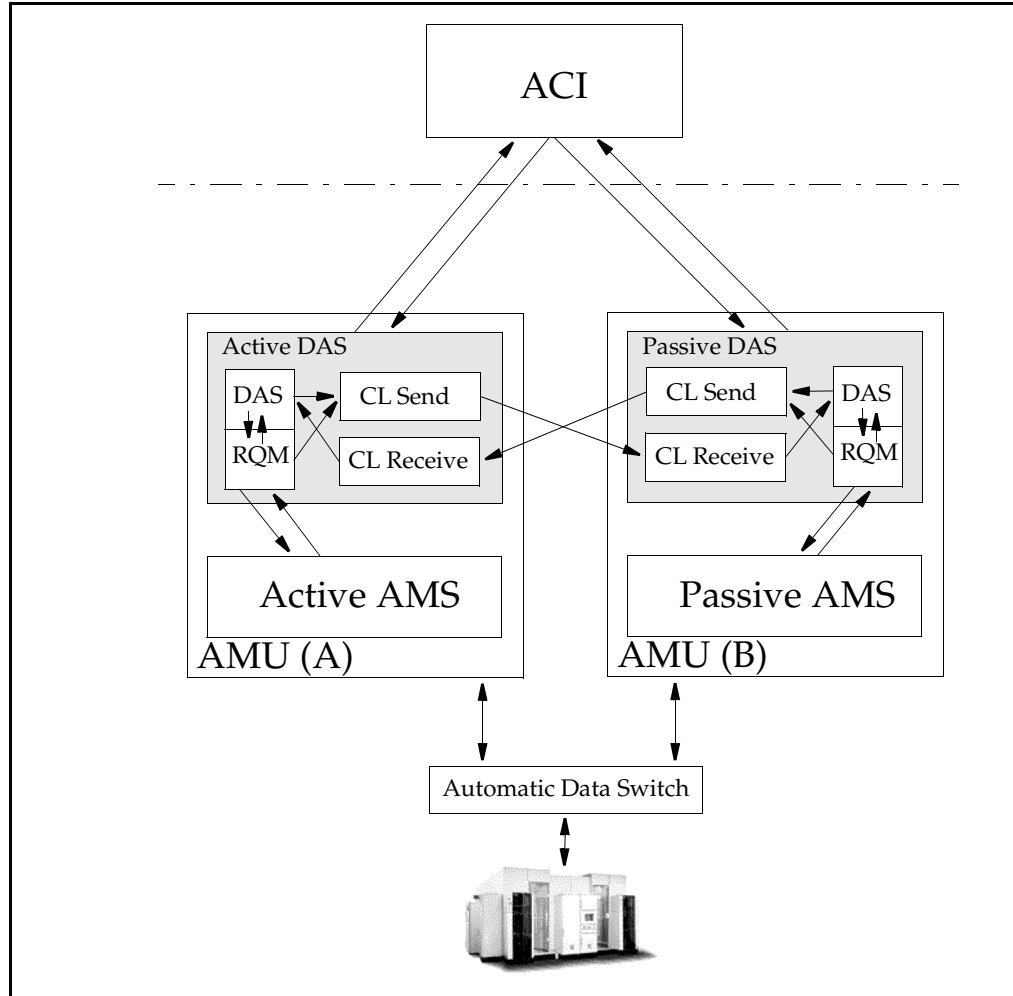

Figure 2-5 Structure of Dual AMU Support

At run time, only one AMU and one DAS are active, while the second AMU is passive. The active server is detected automatically and the DAS command is sent to that server.

The `dasdata.ini` is updated automatically on the passive DAS. In case of a switch, the passive DAS has all actual information about the drive allocation, volser allocation and foreign assignment. If the passive DAS is down, no updates are made between the `dasdata.ini` files. If the ACI cannot find the active DAS, the ACI sends the command to the passive DAS and the passive DAS sends the command to the passive AMU. This only works if the AMU routing is working.

The passive AMU can be switched to active by using the **switch** command. The **switch** command can be executed as normal or with the **force** option. Force means an immediate switch through the passive server without first synchronizing the AMU database with the previously active AMU.

The DAS software refuses new client commands by means of ESWITCHINPROG during the switching process. All commands copied to the previously passive server are checked or executed, and the clients are sent relevant acknowledgment following successful switching.

3

Safety

Overview	3-3
Hazard Alert Messages	3-3
Validity	3-5

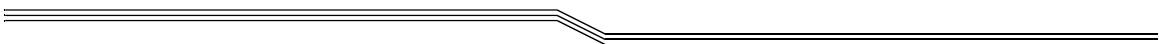

Overview

Note

In addition to the safety instructions in this guide, local and professional safety rules apply.

Knowledge and observance of these instructions is imperative for the safe operation of the ADIC/GRAU Storage Systems AML systems.

Avoid danger when maintaining and operating the machine by

- behaving in a safety-conscious manner
- acting judiciously

Hazard Alert Messages

ADIC classifies hazards in several categories. Table 3-1 shows the relationship of the symbols, signal words, actual hazards, and possible consequences. See Table 3-1.

Table 3-1 Hazard Alert Message







Symbol	Damage to ...	Signal Word	Definition	Consequence
	Persons	DANGER	Imminent hazardous situation	Death or serious injury
		WARNING	Potential hazardous situation	Possible death or serious injury
		CAUTION	Less hazardous situation	Possible minor or moderate injury
	Persons		Imminent hazardous electrical situation	Death or serious injury
	Persons	Caution	Less hazardous situation	Possible minor or moderate injury
	Material	Attention	Potential damaging situation	Possible damage to the product or environment

Table 3-1 Hazard Alert Message

Symbol	Damage to ...	Signal Word	Definition	Consequence
	Material	Static Sensitive	Potential electronic damaging situation	Possible damage to the product
		Note	Tips for operators	No hazardous or damaging consequences
			Important or useful information	No hazardous or damaging consequences

Specially emphasized paragraphs in this guide warn of danger or draw attention to important information. These paragraphs and their associated symbols include:



When used with the signal words, **Danger** or **Warning**, this symbol warns of a dangerous situation that threatens personnel with serious injury or death.

When used with the signal word **Caution**, the symbol warns of a hazardous situation that could result in minor injury.



The danger exists of a fatal electric shock. At places designated with this symbol, electrical current can be present. Before starting any work, always confirm that all electrical connections are free of electrical current.



This symbol indicates the presence of a laser.

Caution - use of controls or adjustments or performance of procedures other than those specified herein may result in hazardous radiation exposure.



This symbol means that specific regulations, rules, notices, and working procedures must be observed. Ignoring this symbol can lead to equipment damage or destruction or to other property damage.



This symbol indicates that the risk of equipment damage exist due to static discharge.



This symbol draws attention to user tips. No dangerous or damaging consequences for personnel or property are associated with this symbol.



This symbol indicates important or useful information. No dangerous or damaging consequences for personnel or property are associated with this symbol.



Validity

 **Note**
Any other
manufacturer's
documentation
forms part of the
AML
documentation.

These instructions are valid for ADIC/GRAU Storage Systems AML systems.

Supplementary safety provisions for any components used on the machine are not invalidated by these instructions.

4

Installation and Configuration

Overview	4-3
Installing the DAS Software	4-3
Installation Using Dasinst.cmd	4-3
Installation Without the Install Program	4-5
Configuring the Server Software	4-7
Editing the Config.sys File	4-7
Editing the Startup.cmd File	4-8
Editing the Config File	4-9
Configuration File	4-10
Structure and Syntax of Config	4-10
Definition of Ranges	4-11
Definition of Volser Ranges	4-11
Options	4-12
Avoid Volume Contention Option	4-12
Dismount Option	4-12
The Client Statement	4-13
Syntax	4-13
The DriveToVol Statement	4-16
Syntax	4-16
The Server Statement	4-16
Syntax	4-16
Configuration File	4-18
DAS Configuration in AMS	4-20
Drives	4-20
I/O Unit	4-21
Scratchpools	4-23
Installing the ACI Software	4-24
UNIX-Client	4-24
Microsoft Windows NT Client Using RPC	4-25
Microsoft Windows NT Client Using RSH	4-26



Configuration DAS Client on the OS/2 PC 4-26	
Configuration Windows for the ACI Client	4-28
Configuration of the UNIX-Client Software	4-29
Example of the C Shell	4-29
Example of the Korn and Bourne Shell	4-29
DAS Environment Variables	4-30

Overview

This chapter describes how to

- Install the DAS software on the AMU PC (OS/2 operating system)
- Configure the server software
- Install the ACI software on a UNIX computer and on Windows NT
- Setting up the working environment for the ACI

Installing the DAS Software

The DAS software for OS/2 is supplied on a diskette with an install program *dasinst.cmd*, an install file and the decompression program. The DAS software for OS/2 also contains the ACI for OS/2 software together with the server and the administrator program *dasadmin*. ADIC/GRAU Storage Systems recommends the use of the install program for the installation, but a manual install is also possible.

Installation Using Dasinst.cmd

- Step 1** If the DAS is running (window DAS/2 in the list task): Stop DAS with
- ```
C:> \das\bin\dasadmin shut now.
```
- See Figure 4-1.

```
C:> \das\bin\dasadmin shut now
```

**Figure 4-1** Command to Stop DAS

- Step 2** Insert the diskette containing the DAS software in the floppy drive of the AMU PC and start the install program. See Figure 4-2.

```
C:> A:\dasinst
```

---

---

**Figure 4-2** Command to Install DAS

**Step 3** Select the install option. See Figure 4-3.

```
GRAU Storage Systems, AMU-Service, 01.01.98 12.00
 I N S T A L L A T I O N U T I L I T Y
 D A S - V E R S I O N 3.01
1 = New Installation of DAS Server Software
 (Installation without backup of an older
Version)
2 = DAS Software Update from DAS 3.x to 3.x
3 = DAS Software Update from DAS 1.30x to 3.x
4 = DAS Software Update from DAS 1.20x to 3.0
5 = Deinstallation of the last update
6 = Deinstallation of complete DAS
7 = End
Select an Option:
```

**Figure 4-3** DAS Installation Utility Menu

**Step 4** Follow the steps of the install program.  
See Figure 4-4

```
If you want to use DUALDAS type 'y' for yes otherwise 'n'
for no:
```

**Figure 4-4** Accepting DUAL DAS Installation

- Choose option **Y**, if you have a DUAL-AMU. More parameter for DUALDAS will be requested afterwards.



**The following two steps are for DUALDAS only.**

```
Type the hostname of the partner-pc:
```

**Figure 4-5** Entering Hostname



- 
- 
- Enter the TCP/IP name of the DUAL-AMU. (for the environment variable DAS\_PARTNER). See Figure 4-6.



```
Type the ip-address of the partner-pc:
```

**Figure 4-6** Entering IP Address

- Enter the TCP/IP address in the form xxx . xxx . xxx . xxx. (assignment host name and IP address will be written in the file hosts)

**Step 5** Copy all the client software into the c:\das\aci directory and follow the instructions.

**Step 6** Remove the diskette from the drive

## Installation Without the Install Program

You can skip this section if you have used the install program with success

**Step 1** Backup any DAS software (if present), and delete all files from the c:\das directory.

**Step 2** Create the directory on your hard disk if it does not exist. See Figure 4-7.



```
C:> md das
```

**Figure 4-7** Command to Make the DAS Directory

**Step 3** Change to the directory. See Figure 4-8.



```
C:> cd das
```

**Figure 4-8** Command to Change to the DAS Directory

- 
- 
- Step 4** Insert the diskette containing the DAS software in the floppy drive of the AMU PC and copy the DAS software into the DAS directory. See Figure 4-9.



```
C\DAS:> copy a:*.zip
```

**Figure 4-9** Command to Copy the Floppy

- Step 5** Remove the diskette from the drive.
- Step 6** Unzip the DAS software. See Figure 4-10.



```
C\DAS:> a:\unzip *.zip
```

**Figure 4-10** Command to Unzip the DAS Software

- Step 7** Copy all the tar files from the second and third floppy to the `c:\das\aci` directory.
- Step 8** After installation is complete, the manual update of the `config.sys` file is necessary Refer to *Editing the Config.sys File* on page 4-7.

---

---

## Configuring the Server Software

The following sections provide information on editing the server software.

### Editing the Config.sys File

ADIC/GRAU Storage Systems recommends that the following amendments be made in the *config.sys* file so that the administrator functions can be accessed on the OS/2 computer. The Libpath and the variables DAS\_SERVER, DAS\_CLIENT and DAS\_PARTNER will be written by the installation program.

**Step 1** Open the *config.sys* file in the editor. See Figure 4-11.

```
C:> epm c:\config.sys
```

**Figure 4-11** Command to Edit the Config.sys File

**Step 2** Amend or add the following lines in *config.sys*. See Figure 4-12. Refer to *DAS Environment Variables* on page 4-30

```
LIBPATH=...C:\DAS\BIN;
SET DAS_SERVER=AMUA,AMUB
SET DAS_PARTNER=AMUB
SET DAS_CLIENT=AMUADMIN
SET DAS_AUTOSWITCH=YES
SET DAS_EJECTAREAFULL=1
```

**Figure 4-12** Modifying the Config.sys File

**Step 3** Save *config.sys*.

**Step 4** Restart the OS/2 computer to activate the changes to the configuration.



**This restart is only necessary after a new installation.**

---

---

## Editing the Startup.cmd File

ADIC/GRAU Storage Systems recommends that the following amendments be made in the *startup.cmd* file so that the DAS software is started automatically on the OS/2 computer during startup.

**Step 1** Open the *startup.cmd* file in the editor.  
See Figure 4-13

```
C:> epm c:\startup.cmd
```

**Figure 4-13** Command to Edit the Startup.cmd File

**Step 2** Amend or add the following lines in *startup.cmd*.  
See Figure 4-14.

```
call tcpstart
das\tools\os2sleep 20

CD \AMU
START CON
START KRN

cd \das
tools\os2sleep 20
call dasstart
cd bin
start DAS/2 AmuClient
exit
```

**Figure 4-14** Modifying the Startup.cmd File

**Step 3** Save *startup.cmd*.



**This sample file for the *startup.cmd* is installed under *c:\das\tools\startup.smp*. An explanation of the individual points in the *startup.cmd* file can be found in the AMU Reference Manual**

---

---

## Editing the Config File

The config file contains all settings for access privileges, drive assignment and command options. A sample of this file is stored as `c:\das\etc\config.smp` during installation.

**Step 1** For manual and first time installation, copy the `config.smp` sample file to `config`. See Figure 4-15.

```
C:> copy \das\etc\config.smp das\etc\config
```

**Figure 4-15** Command to Copy the Config.smp File

**Step 2** Open `config` in the editor. See Figure 4-16.

```
C:> epm \das\etc\config
```

**Figure 4-16** Command to Edit Config

**Step 1** Amend or add to `config`

**Step 2** Save `config`.

---

---

## Configuration File

This section describes editing the *config* file and editing the statement structure.

### Structure and Syntax of Config

Entries in the *config* file are structured according to the following scheme. See Figure 4-17.

```
Statement_name Keyword_name1 = Keyword_parameter1,
 Keyword_name2 = ...
```

**Figure 4-17** Example of Config File Entries

There are three types of statements here:

- Client statement
- DriveToVol statement
- Server statement

Any line may contain a maximum of 100 characters. No special characters are permitted for variables in the file (except for the TCP/IP host names and client names). The special characters -, \_, + and \$ may be used in the TCP/IP host name and client name. The layout of the file (order of statements, blank lines and spaces) is free, although ADIC/GRAU Storage Systems recommends the structure of the sample file as giving a clearer overview. Comment lines may be added if they begin with the “#” character. See Figure 4-18.

```
This line is comment
client clientname = AMUCLIENT,
 hostname = AMU,# this is a comment from here on
```

**Figure 4-18** Example of Comment Lines

---

---

## Definition of Ranges

Devices are assigned to the individual clients by the definitions in the *config* file. This assignment is made in logical ranges in the AML. See Figure 4-19. A logical range can be:

- a list of individual objects
- a continuous range
- an individual object
- keyword *ALL*

```
range = item |
 item, item, ... |
 item-item |ALL# contains all objects
```

**Figure 4-19** Assigning Device

## Definition of Volser Ranges

The definition of the volser ranges is a special form of the definition of logical ranges. The following rules apply for the volsers:

- A volser can have up to 16 alphanumeric characters
- Lowercase and uppercase letters (no special characters) and the numerals 0 to 9 are valid characters.
- The number and type of characters at the beginning and end of a range definition must match (e.g. ABC001 - ABC999 or 0001001 - 5638516 or 00aaAAa - 99zzZZZ).
- "a - Z" ranges also contain the numerals 0 to 9

---

---

## Options

This section describes the avoid volume contention and dismount options.

### Avoid Volume Contention Option

This option defines the error handling for a mount command on a volser which is not located at the home position or drive on which is loaded with a cleaning cartridge.

**avc:** The command is immediately acknowledged negatively for a mount command on a volser which has the attribute *Mounted*, *Reverse\_Side\_Mounted*, *Ejected* in the AMU database or if there is a cleaning cartridge in the drive.

**no\_avc:** For a mount command on a volser which has the attribute *Mounted*, *Reverse\_Side\_Mounted*, *Ejected* in the AMU database or if there is a cleaning cartridge in the drive, the command is placed in the command queue and suspended until

- The volser is shifted to the home position by a **dismount** command.
- DAS is terminated.

The default (no specification in the *config* file) is **no\_avc**.

### Dismount Option

This option defines the reaction to a mount command on a drive that is already occupied.

**dismount:** The command is immediately acknowledged negatively for a mount command on a drive which has the attribute *Occupied*. This requires that the client sends a **dismount** command.

**no\_dismount:** The command is placed in the command queue and a dismount command is automatically generated on this drive for a mount command on a volser which has the attribute *Occupied* in the AMU database.

The default (no specification in the *config* file) is **no\_dismount**.



---

---

## The Client Statement

A client statement is required for each client that accesses the server. The maximum possible number of client statements is 50.

### Syntax

Figure 4-20 shows the syntax of the client statement.

```
client client_name = client-name
 , hostname = workstation_network_name | ,
ip_address = ip address
 [, requests = (basic | complete)]
 [,
options=([avc|no_avc] [,dismount|no_dismount]])
 [, volumes = ((volume range), (volume
range), ...)]
 [, drives = ((drive range))]
 [, inserts = ((insert area range))]
 [, ejects = ((eject area range))]
 [, scratchpools = ((scratchpools range))]
```

**Figure 4-20** Client Statement

Refer to Table 4-1 on page 4-13 for an explanation of the keywords in the client statement.

**Table 4-1** Client Statement

| Keyword    | Explanation                                                                                                                                                                                                                                                                                                                                                                                                                                                                                                                     |
|------------|---------------------------------------------------------------------------------------------------------------------------------------------------------------------------------------------------------------------------------------------------------------------------------------------------------------------------------------------------------------------------------------------------------------------------------------------------------------------------------------------------------------------------------|
| clientname | Name of the client (the name must not be the client's TCP/IP name).<br>The following rules apply for the client name: <ul style="list-style-type: none"><li>• The client name may consist of up to 64 characters</li><li>• Lowercase and uppercase letters and the numerals 0 to 9 are valid characters in the client name.</li><li>• Special characters -, _, + and \$</li><li>• The client name is case-sensitive</li></ul> The client name DAS_SUPERVISOR has the special privilege of reserving drives and undoing volsers. |

**Table 4-1** Client Statement

| <b>Keyword</b>    | <b>Explanation</b>                                                                                                                                                                                                                                                                                                                                                                                                                                                                   |
|-------------------|--------------------------------------------------------------------------------------------------------------------------------------------------------------------------------------------------------------------------------------------------------------------------------------------------------------------------------------------------------------------------------------------------------------------------------------------------------------------------------------|
| host_name         | <p>The name of the relevant IP address of the client. The name must be resolved either through the <i>hosts</i> file or through a domain name server.</p> <p>The following rules apply for the names:</p> <ul style="list-style-type: none"><li>• The host name may consist of up to 64 characters.</li><li>• Lowercase and uppercase letters, the numerals 0 to 9 and up to 6 stops are valid characters in the host name.</li><li>• Special characters -, _, +, . and \$</li></ul> |
| ip_address        | <p>The IP address of the client</p> <p>The IP address has the format xxx . xxx . xxx . xxx.</p>                                                                                                                                                                                                                                                                                                                                                                                      |
| requests          | <p>Access privileges for the client.</p> <ul style="list-style-type: none"><li>• <i>basic</i>: only mount and dismount commands are permitted</li><li>• <i>complete</i>: all commands are permitted</li></ul>                                                                                                                                                                                                                                                                        |
| options           | <p>Flow control option, refer to <i>Options</i> on page 4-12</p> <ul style="list-style-type: none"><li>• <b>dismount</b> or <b>no_dismount</b>: Automatic <b>KEEP</b> command</li><li>• <b>avc</b> or <b>no_avc</b> (avoid volume completion) wait for the <b>KEEP</b> command of a volume which is already in use.</li></ul>                                                                                                                                                        |
| volumes           | <p>Assignment of the volser ranges available to the client</p> <p>Up to 10 volser ranges can be assigned per client</p>                                                                                                                                                                                                                                                                                                                                                              |
| drive range       | <p>Assignment of drives available to the client in a range, e.g. (DRV_VHS, DRV_DLT, DRV_3480), or (DLT1 - DLT4) or (ALL). The name must match that in the <i>description</i> field of the AMS configuration.</p>                                                                                                                                                                                                                                                                     |
| insert area range | <p>Assignment of ranges available to the client (<b>Logical Range</b>) in the I/O unit for inserting media, e.g. (I01, I07, I66) or (I01 - I37) or (ALL). The coordinates are assigned in the AMS configuration. It is possible to interleave other operators or ejection fields with insertion fields.</p>                                                                                                                                                                          |
| eject area range  | <p>Assignment of ranges (Logical Range) in the I/O unit available to the client for ejecting media, e.g. (E01, E09, E99) or (E05 - E47) or (ALL). The coordinates are assigned in AMS configuration. It is possible to overlap with other users or other insertion fields.</p>                                                                                                                                                                                                       |

**Table 4-1** Client Statement

| <b>Keyword</b>      | <b>Explanation</b>                                                                                                                                                                                                                                                                                                                                                                                                                                                                                                                                                                                                                                                                                                                                                                                                                                                                                                      |
|---------------------|-------------------------------------------------------------------------------------------------------------------------------------------------------------------------------------------------------------------------------------------------------------------------------------------------------------------------------------------------------------------------------------------------------------------------------------------------------------------------------------------------------------------------------------------------------------------------------------------------------------------------------------------------------------------------------------------------------------------------------------------------------------------------------------------------------------------------------------------------------------------------------------------------------------------------|
| scratch pools range | <p>Assignment of scratch pools available to the client. Scratch pool administration is configured in AMS configuration. Assignment can be by</p> <ul style="list-style-type: none"><li>• media type</li><li>• client or client group.</li></ul> <p>Different media types cannot be managed together in one scratch pool. The following rules apply for the scratch pool names.</p> <ul style="list-style-type: none"><li>• The pool name may consist of up to 16+1 characters</li><li>• Lowercase and uppercase letters (no special characters) and the numbers 0 to 9 are valid characters in the pool name.</li><li>• The keyword <i>ALL</i> gives access to all scratch pools.</li><li>• The keyword <i>DEFAULT</i> gives access to all default scratch pools.</li><li>• Default scratch pool names are formed from a combination of the word <i>DEFAULT</i> and the AMU media type, e.g. <i>DEFAULTC0</i></li></ul> |

---

---

## The DriveToVol Statement

The DriveToVol statement can be used for any drive in the AML system. Volser ranges are assigned to specified drives by this statement. Media type (AMU) verification is independent of this statement.

### Syntax

Figure 4-21 shows an example of the DriveToVol statement.

```
DriveToVol drive = drive-name,
volsers = ((volumerange), (volumerange), .)
```

**Figure 4-21** DriveToVol Statement



**Each drive needs its own, complete statement. Drive ranges are not possible.**

See Table 4-2 gives an explanation of the keywords used in the DriveToVol statement.

**Table 4-2** Drive to Volser Range

| Keyword      | Explanation                                                                                           |
|--------------|-------------------------------------------------------------------------------------------------------|
| drive-name   | Name of the drive to which volsers are to be assigned. (Drive name according to configuration in AMS) |
| volume range | Range of volsers to be assigned to the drive                                                          |

## The Server Statement

The server statement can be entered once in the *config* file. This sets optional parameters for operating the dual DAS and for error handling. The server statement is required.

### Syntax

Figure 4-22 on page 4-17 shows an example of the server statement.

```





server [dualdas_port = port_number]
 [, retry_keep = retry_number]
 [, timeout_move = time]
 [, timeout_ei = time],
 [logging_off = command]

```

**Figure 4-22** Server Statement

See Table 4-3 for an explanation of the keywords used in the server statement.

**Table 4-3** Optional Parameters

| Keyword                                                                                             | Explanation                                                                                                                                                                                                                                                                                                                                    |
|-----------------------------------------------------------------------------------------------------|------------------------------------------------------------------------------------------------------------------------------------------------------------------------------------------------------------------------------------------------------------------------------------------------------------------------------------------------|
| dualdas_port                                                                                        | TCP/IP port address for communication between the active DAS and the passive DAS. (Default: 5000) The default value must be modified if another application is occupying port 5000.                                                                                                                                                            |
| retry_keep<br>   | Number of internal iterations of the dismount command for an AMU error of type "Cartridge not ejected from drive for.<0420>".<br><b>The dismount manager in the AMS software is equally capable of executing this error handling. Make sure that the command is configured so that it is not timed out as a result of too many iterations.</b> |
| timeout_move<br> | Time in seconds, between the start of a mount or dismount command and the response. If the command needs more time, the response is ETIMEOUT.<br>Default: 1800<br><b>For higher values, change the timeout values for the client. Change the environment variables on the client.</b>                                                          |
| timeout_ei<br>   | Time in seconds, between the start of a insert or eject command and the respond. If the command need more time is the response ETIMEOUT.<br>Default: 1800<br><b>For higher values, change the timeout values for the client. Change the environment variables on the client.</b>                                                               |
| logging_off<br>  | Used to switch off log messages for DAS commands, use the name of the DAS ADMIN command.<br><b>Currently, only the listd commands are supported.</b>                                                                                                                                                                                           |

---

---



## Configuration File

Figure 4-23 on page 4-19 shows the combined use of all of the previously defined statements.

```

client client_name = DAS_SUPERVISOR,
 hostname = AMU,
 requests = complete,
 options = (no_avc,no_dismount),
 volumes = ((ALL)),
 drives = ((ALL)),
 inserts = ((ALL)),
 ejects = ((ALL)),
 scratchpools = ((ALL))

client client_name = client,
ip_address = xxx.xxx.xxx.xxx,
 hostname = clienthost,
 requests = basic,
 options = (avc,dismount),
 volumes = ((xxxxxxx - xxxxxx)),
 drives = ((xxx,xxx)),
 inserts = ((I01)),
 ejects = ((E01)),
 scratchpools = ((ALL,DEFAULT))

client client_name = dasadmin,
 hostname = unixhost,
 requests = complete,
 volumes = ((ALL)),
 drives = ((ALL)),
 inserts = ((ALL)),
 ejects = ((ALL)),
 scratchpools = ((ALL))

DriveToVol drive = DLT01,
 volsers = ((000001),(000004 - 000999))

DriveToVol drive = ODISK01,
 volsers = ((000002),(00A - 99B))

DriveToVol drive = Drive2,
 volsers = ((000002),(000007 - 000010))

server dualdas_port = 5000,
 retry_keep = 5,
 timeout_move = 1800,
 timeout_ei = 1800,
 logging_off = listd

```

**Figure 4-23** Example of the Configuration File

---

---

## DAS Configuration in AMS

The settings must be compatible in order for DAS to function correctly with the AMS. The settings in AMS with regard to the DAS software are described below. You can find precise information on the AMS configuration in the AMU Reference Manual.

The settings are made in the *Admin - Configuration...* menu. See Figure 4-24.

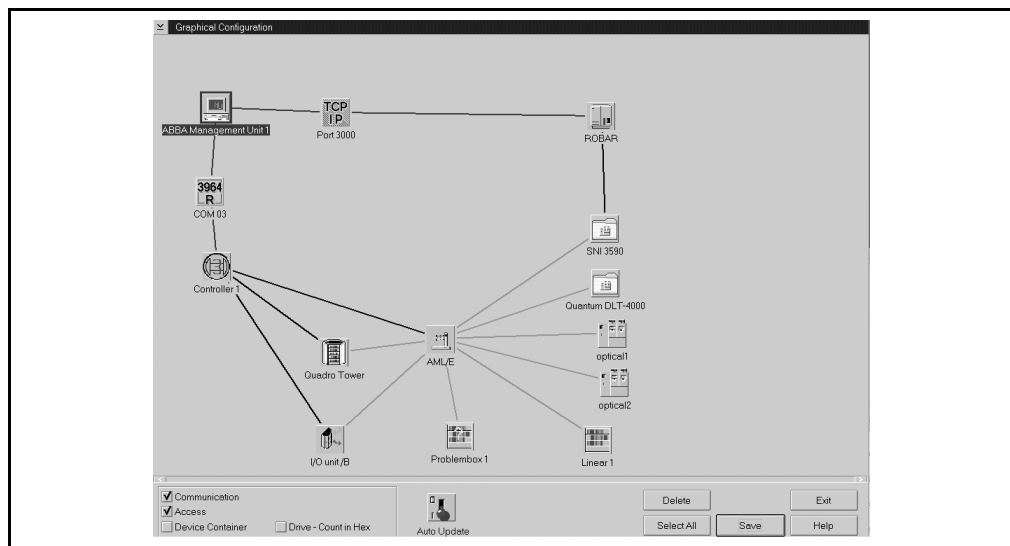

**Figure 4-24** Graphical Configuration Window

DAS is not shown as the host in AMS configuration.

## Drives

- Step 1** Open the *Drive Configuration* window by double-clicking on the drive icon. Refer to Figure 4-25 on page 4-21.



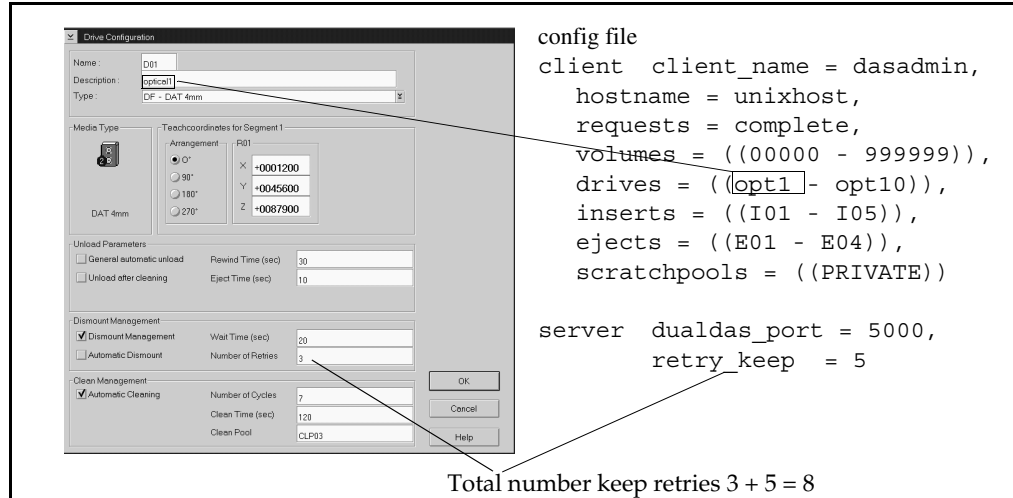

Figure 4-25 AMS-DAS Configuration for Drives

Step 2 Modify the configuration

Step 3 Finish configuration by clicking on OK

## I/O Unit

Step 1 Open the *EIF-Configuration* window by double-clicking on the I/O unit icon. See Figure 4-26.

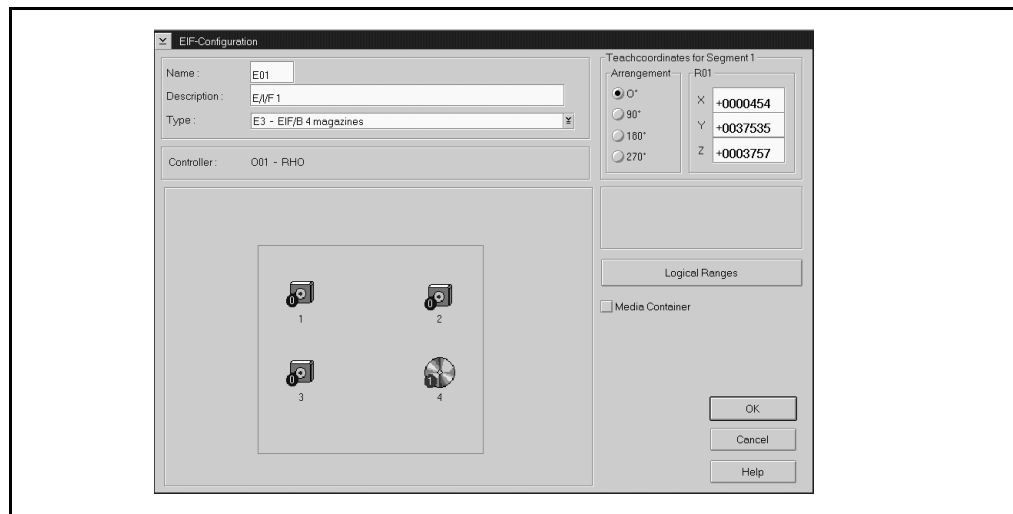
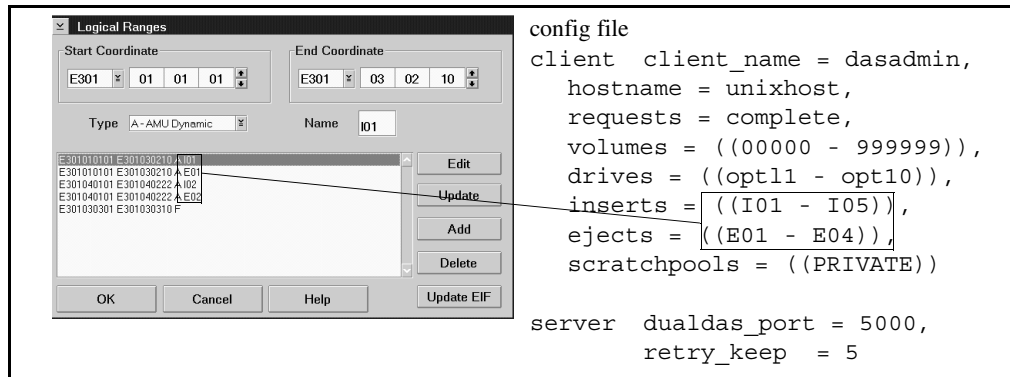

Figure 4-26 EIF-Configuration Window

**Step 2** Open the relevant window by clicking on the *Logical Ranges* field. See Figure 4-27.



**Figure 4-27** AMS-DAS Configuration for EIF Ranges

**Step 3** Modify the configuration.

- Add insertion ranges  
(Type: *AMU Dynamic*, Name: Ixx, where xx is 01-99)
- Add ejection ranges  
(Type: *AMU Dynamic*, Name: Exx, where xx is 01-99)
- Add foreign mount ranges  
(Type: *Foreign*)



**Each name may only be defined once in the list. Ranges of type AMU Dynamic may interleave. It is not permissible to interleave ranges of type foreign and HCC Dynamic.**

**Step 4** Quit the Logical Range window by clicking *OK*

**Step 5** Quit EIF-Configuration window by clicking *OK*

**Step 6** Save the changes by clicking *Save*

**Step 7** Open *EIF-Configuration* and *Logical Ranges* window once more

**Step 8** Modify the database with *Update EIF*

---

---

## Scratchpools

**Step 1** Open *Admin Scratch Pool..* from the menu. Refer to Figure 4-28 on page 4-23

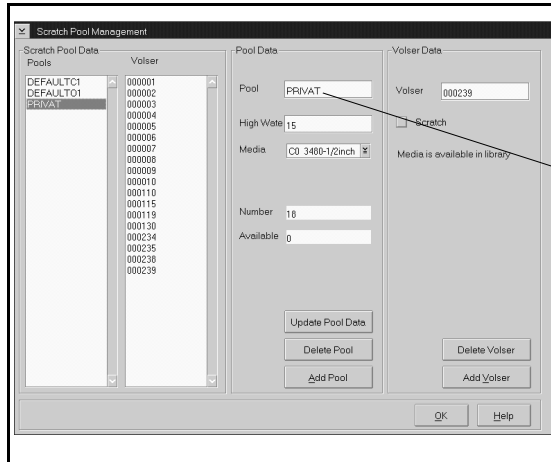

```
config file
client client_name = dasadmin,
 hostname = unixhost,
 requests = complete,
 volumes = ((00000 - 999999))
 drives = ((opt1 - opt10)),
 inserts = ((I01 - I05)),
 ejects = ((E01 - E04)),
 scratchpools = ((PRIVATE))

server dualdas_port = 5000,
 retry_keep = 5
```

**Figure 4-28** Scratchpool Configuration

---

---

## Installing the ACI Software

This section describes the process for installing the ACI software for a UNIX-client and for a Windows NT client

### UNIX-Client

During the DAS installation, the ACI software is copied into the `c:/das/aci` directory. The desired tar file can be copied with a FTP program to the UNIX machine.

- Step 1** Create a directory for the ACI software.  
See Figure 4-29.

```
$ mkdir /usr/local/aci
```

**Figure 4-29** Command to Make Directories

- Step 2** Copy the ACI software to the directory created (ftp from the AMU)

— or —

(configuration of the OS/2 ftp) Refer to the *AMU Installation Guide*.

Refer to Figure 4-30 on page 4-24.

```
$ cd /usr/local/aci
$ ftp amu_hostname
userid> useid
password> password
ftp> bin
ftp> get das/aci/filename
ftp> quit
```

**Figure 4-30** FTP Copy of ACI Software

- Step 3** Decompress the files to the `/usr/local/aci` directory. Refer to Figure 4-31 on page 4-25.

---

---

```
$ tar -xvf /usr/local/aci/filename
```

**Figure 4-31** Example of TAR Compression

## Microsoft Windows NT Client Using RPC

- Step 1** Create the `c:\aci` directory.
- Step 2** Enter the *ACI for and Windows NT* disk in the drive `a:`
- Step 3** Unpack the file *aci zip-file* into the `c:\aci` directory.
- Step 4** Copy the file *aci.dll*, *ezrpc32.dll*, *winrpc32.dll* and *dasadmin.exe* into your Windows system directory. (On Windows NT 4.0 it is the: `\winnt\system32` directory).
- Step 5** Open *Control Panel/System/Environment*.
  - Extend the path environment variable with ACI installation directory `c:\aci`.
  - Define the environment variable `DAS_SERVER`. The value is the hostname where DAS-server is running.
  - Define the environment variable `DAS_CLIENT`. The value is the clientname of the NT client which is defined in the DAS config file on the OS/2 computer.
- Step 6** Change to the `c:\aci` directory.
- Step 7** Install the portmapper by typing `portinst`. The portmapper should be set to start automatically during the start of NT.
- Step 8** Remove the disk from the `a:` drive.
- Step 9** Reboot the NT machine.

---

---

## Microsoft Windows NT Client Using RSH

This section describes the process for configuring DAS clients on the OS/2 PC. For further information refer to *Configuration DAS Client on the OS/2 PC* on page 4-26 of the DAS Interfacing guide for Windows 95/NT.

### Configuration DAS Client on the OS/2 PC

**Step 1** Enter the disk in the AMU-PC

**Step 2** Open an OS/2 window and enter.  
Refer to Figure 4-32 on page 4-26.

```
C:> copy a:aci.cmd c:\os2
```

**Figure 4-32** Command to Copy ACI Software

**Step 3** Edit the C:\DAS\ETC\CONFIG file by entering C:> epm c:\das\etc\config. See Figure 4-33.

```
C:> epm c:\das\etc\config
```

**Figure 4-33** Command to Edit the Config File

**Step 4** Add a new client to the list of DAS clients. Refer to Figure 4-34 on page 4-27.



**For Dual AMU operations, it is recommended that both AMU client\_names should be added to the configuration file.**

client\_name: alphanumeric name for authorization

ip\_adress or hostname: TCP/IP identification of OS/2 PC (AMU)

requests: complete

---

---

|          |                                                                                         |
|----------|-----------------------------------------------------------------------------------------|
| options: | (avc, dismount)                                                                         |
| volumes: | up to 10 ranges of the media names                                                      |
| drives:  | alphanumeric names similar to the Description in the Graphical Configuration in the AMU |

```
client client_name = arcserve,
ip_address = 192.63.193.60,
hostname = AMU,
requests = complete,
options = (avc,dismount),
volumes = ((OD0001 - OD9999)),
drives = ((LIBRARYA-LIBRARYZ))
```

**Figure 4-34** Adding a New Client

- Step 5** Select TCP/IP and TCP/IP Configuration Icon to open the Window TCP/IP Configuration
- Step 6** Configure and Start the RSH daemon on the AMU PC
- Step 7** Configure the Security for the RSH (Add the HOST-Name of the Windows-NT machine to the list "HOST authorized to use RSH")
- Step 8** Configure and Start a Telnet Deamon on the AMU PC (optional for VirOp Administrator menu)
- Step 9** Save the CONFIG file on a floppy for print out.
- Step 10** Close all applications on the AMU PC and restart the PC

---

---

## Configuration Windows for the A Client

**Step 1** Set the necessary environment variables:



The following configuration is only necessary if you work with the *dasadmin* command line.

See Table 4-4 for an explanation of the variables in configuring Windows for ACI.

**Table 4-4** Variables

| Variable       | Explanation                                                                                                         |
|----------------|---------------------------------------------------------------------------------------------------------------------|
| DAS_SERVER     | TCP/IP Identification of the AMU (OS/2) PC for the commands                                                         |
| DAS_CLIENT     | Name for authorization of the command related to the configuration in file <code>config</code> on the AMU (OS/2) PC |
| ACI_MEDIA_TYPE | Default media type for the commands                                                                                 |

Figure 4-35 on page 4-28 shows an example of setting the variables.

```
set DAS_SERVER=AMU
set DAS_CLIENT=arcserve
set ACI_MEDIA_TYPE=DECDLT
```

**Figure 4-35** Setting Variables



Start the environment variables on the startup with *AUTOEXE.BAT* or your on login script.



---

---

## Configuration of the UNIX-Client Software

Configuration of the client is dependent on the platform used and the application which is to access the AML system. Instructions on certain points can be found in the *Notes on the Applications* on page A-3.

For use of the ACI

- the library files must be made accessible to the system (set *LIBPATH* or create an association)
- the environment variables must be set.

The two examples of environment variable configuration follow.

### Example of the C Shell

Alternatively the variables can also be entered in the *.cshrc* file to make the values universally valid. Refer to Figure 4-36 on page 4-29.

```
setenv DAS_SERVER AMUA,AMUB
setenv DAS_CLIENT dasadmin
setenv ACI_MEDIA_TYPE DECDLT
setenv ACI_TIMEOUT_MOVE 1800
setenv ACI_TIMEOUT_EI 1800
```

Figure 4-36 Setting Environmental Variables

### Example of the Korn and Bourne Shell

Alternatively the variables can also be entered in the *.profile* (Korn shell) or *.login* (Bourne shell) file to make the values universally valid. See Figure 4-37.

```

DAS_SERVER=AMUA,AMUB; export DAS_SERVER
DAS_CLIENT=dasadmin; export DAS_CLIENT
ACI_MEDIA_TYPE=DECDLT; export ACI_MEDIA_TYPE
ACI_TIMEOUT_MOVE=1800; export ACI_TIMEOUT_MOVE
ACI_TIMEOUT_EI=1800; export ACI_TIMEOUT_EI

```

**Figure 4-37** Setting Variables

## DAS Environment Variables

The environment variables listed must be set for each client. Refer to Table 4-5 on page 4-30.

**Table 4-5** Environment Variable for DAS

| Parameter      | Parameter type   | Explanation                                                                                                                                                                                                                                                                |
|----------------|------------------|----------------------------------------------------------------------------------------------------------------------------------------------------------------------------------------------------------------------------------------------------------------------------|
| DAS_SERVER     | required for ACI | Network names (TCP/IP) of the server which are accessed by the dasadmin program. Both names are entered separated by a comma, only when installing dual DAS. The names must be resolvable on the computer into TCP/IP addresses ( <i>hosts</i> file or domain name server) |
| DAS_CLIENT     | required for ACI | Name of the client under which the OS/2 PC is to access the server. The name must be defined in the config file. The use of the client name DAS_SUPERVISOR makes it possible to reserve drives and undo volsers of other clients.                                          |
| ACI_MEDIA_TYPE | optional for ACI | Media type selected when using <i>dasadmin</i> if the parameter -t is omitted from the command<br>Default: 3480                                                                                                                                                            |

**Table 4-5** Environment Variable for DAS

| <b>Parameter</b>  | <b>Parameter type</b>                  | <b>Explanation</b>                                                                                                                                                                                                                          |
|-------------------|----------------------------------------|---------------------------------------------------------------------------------------------------------------------------------------------------------------------------------------------------------------------------------------------|
| DAS_EJECTAREAFULL | optional for DAS                       | Reaction to the AMU message <1157>. There is no free eject position in EIF-device.<br>1: message to the client (new command to continue)<br>2: no message to the client (automatic continuation once the range has been opened and cleared) |
| DAS_PARTNER       | required for DAS if Dual-AMU installed | information for the Server software, where the Dual-DAS is installed.                                                                                                                                                                       |
| ACI_TIMEOUT_MOVE  | optional for ACI                       | Time for the ACI to wait for the response to the commands mount and dismount.<br>Default: 1800 seconds                                                                                                                                      |
| ACI_TIMEOUT_EI    | optional for ACI                       | Time for the ACI to wait for the response to the commands insert, insert2, eject, eject2, ejectcl<br>Default: 1800 seconds                                                                                                                  |



# 5

## DAS Commands

|                                                        |      |
|--------------------------------------------------------|------|
| Overview .....                                         | 5-3  |
| DAS Command Classifications .....                      | 5-3  |
| Client Management Commands .....                       | 5-3  |
| Media Management Commands .....                        | 5-4  |
| DAS Management Commands .....                          | 5-5  |
| Scratch Management Commands .....                      | 5-6  |
| Command Description .....                              | 5-7  |
| Change Drive Reservation (allocd) .....                | 5-7  |
| Reserve Volsers (allocv) .....                         | 5-8  |
| Activate/Deactivate the Barcode Reader (barcode) ..... | 5-9  |
| Cancel Commands (cancel) .....                         | 5-10 |
| Catalog Foreign Volume (catf) .....                    | 5-10 |
| Drive Cleaning (clean) .....                           | 5-12 |
| Retrieve a Medium from the Drive (dismount) .....      | 5-13 |
| Eject Media (eject2) .....                             | 5-14 |
| Eject Media (eject) .....                              | 5-16 |
| Eject Cleaning Cartridges (ejectcl) .....              | 5-17 |
| Flip Optical Disk in the Drive (flip) .....            | 5-18 |
| Display Volser for Drive (getvolsertodrive) .....      | 5-19 |
| Assign Volsers to an Optical Disk (getvoltoside) ..... | 5-20 |
| Insert Media (insert2) .....                           | 5-21 |
| Insert Media (insert) .....                            | 5-22 |
| Compare Volsers in the AML (inventory) .....           | 5-23 |
| Shut Down the AMU PC (killamu) .....                   | 5-24 |
| Display All Active Commands (list) .....               | 5-25 |
| Display Drive Assignment .....                         | 5-27 |
| Listd3 .....                                           | 5-27 |
| Listd2 .....                                           | 5-29 |
| Listd .....                                            | 5-31 |

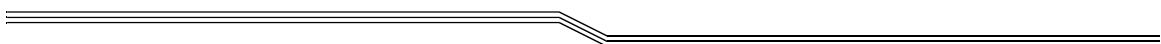

---

---

|                                                          |      |
|----------------------------------------------------------|------|
| Display Volser Reservation (listv) .....                 | 5-33 |
| Load Cartridge in Drive (mount) .....                    | 5-34 |
| Compare Volser Ranges (PartInventory) .....              | 5-35 |
| Query the Software Version (qversion) .....              | 5-36 |
| Query the Volser Ranges in the AML (qvolsrange) .....    | 5-36 |
| Remove a Foreign Medium (rmf) .....                      | 5-39 |
| Deactivate Robotic Controller in the AML (robhome) ..... | 5-40 |
| Activate Robotic Controller in the AML (robstat) .....   | 5-41 |
| Set Access Privileges (scap) .....                       | 5-42 |
| Set Operating Parameters (scop) .....                    | 5-43 |
| Next Scratch Medium (scr_get) .....                      | 5-44 |
| Scratch Pool Information (scr_info) .....                | 5-45 |
| Insert Scratch Media (scr_insert) .....                  | 5-46 |
| Execute Scratch Mount (scr_mount) .....                  | 5-47 |
| Add Media to the Scratch Pool (scr_set) .....            | 5-48 |
| Remove Medium from Scratch Pool (scr_unset) .....        | 5-49 |
| Display Client Parameters (show) .....                   | 5-50 |
| Shut Down DAS (shutdown) .....                           | 5-52 |
| Switch to the Passive AMU (switch) .....                 | 5-52 |
| Operate Drive Buttons (unload) .....                     | 5-53 |
| Obtain Information on a Volser (view) .....              | 5-54 |

---

---

## Overview

The DAS administrator can use the commands to set up and monitor the AML system. This chapter provides full explanation of all commands in alphabetical order. A brief illustration of the syntax can be obtained online by entering the command using the `-h` option.

## DAS Command Classifications

DAS commands are divided into:

- Client management
- Media management
- DAS management
- Scratch management

All these commands are called with *dasadmin*

- from the `C:\DAS\BIN` directory on the OS/2 client
- from the `/usr/local/aci/admin` directory on the UNIX client
- from the system directory `\winnt\system32`

## Client Management Commands

This section provides a list and an explanation of the client management commands. See Table 5-1.

**Table 5-1** Client Management Commands

| Command | Explanation                                    |
|---------|------------------------------------------------|
| allocd  | changes drive reservation for clients          |
| allocv  | reserves volsers for a client                  |
| listd   | displays drive assignment for up to 16 drives  |
| listd2  | displays drive assignment for up to 250 drives |
| listd3  | displays drive assignment for up to 250 drives |
| listv   | displays volser reservations                   |
| scop    | temporarily modifies the working parameters    |

---

---

**Table 5-1** Client Management Commands

| Command | Explanation                                                 |
|---------|-------------------------------------------------------------|
| scap    | temporarily modifies access privileges                      |
| show    | displays current access privileges and operating parameters |

## Media Management Commands

This section provides a list and an explanation of the media management commands. See Table 5-2.

**Table 5-2** Media Management Commands

| Command          | Explanation                                                              |
|------------------|--------------------------------------------------------------------------|
| catf             | catalogs foreign media                                                   |
| clean            | cleans drive                                                             |
| dismount         | removes a cartridge from a drive and returns it to its original position |
| eject            | ejects cartridges from the AML (limited numbers)                         |
| eject2           | ejects cartridges from the AML                                           |
| ejectcl          | ejects cleaning cartridges from the AML                                  |
| flip             | flips the optical disk in the drive                                      |
| getvolsertodrive | displays the configured assignment of volsers to drives                  |
| getvoltside      | displays information on the association of volsers to an optical disk.   |
| insert           | inserts a few cartridges in the AML                                      |
| insert2          | inserts many cartridges, including cleaning cartridges, in the AML       |
| mount            | load cartridge with a volser into a drive                                |
| inventory        | AMU database of the whole AML system checked and corrected               |
| PartInventory    | AMU database of part of the AML system checked and corrected             |
| qvolsrange       | displays the volser from the AMU database for a specified range          |



---

---

**Table 5-2** Media Management Commands

| <b>Command</b> | <b>Explanation</b>                                                                              |
|----------------|-------------------------------------------------------------------------------------------------|
| rmf            | removes foreign media from the catalog                                                          |
| unload         | the robotic controller in the AML system operates the buttons on the drive (e.g. unload button) |
| view           | displays information from the AMU database relating to a volser                                 |

## DAS Management Commands

This section provides a list and an explanation of the DAS management commands. See Table 5-3.

**Table 5-3** DAS Management Commands

| <b>Command</b> | <b>Explanation</b>                                                         |
|----------------|----------------------------------------------------------------------------|
| barcode        | deactivates the AML barcode reader for the mount, carry and eject commands |
| list           | displays the DAS command queue                                             |
| cancel         | deletes a command from the command queue                                   |
| qversion       | displays the DAS and ACI version                                           |
| killamu        | terminates AMU software (DAS, AMS and OS/2)                                |
| robhome        | makes the AML system inactive                                              |
| robstat        | makes the AML system active or queries status                              |
| shutdown       | shuts down the DAS software                                                |
| switch         | switches between active and passive DAS for dual DAS                       |

---

---

## Scratch Management Commands

This section provides a list and an explanation of the scratch management commands. See Table 5-4.

**Table 5-4** Scratch Management Commands

| <b>Command</b> | <b>Explanation</b>                                               |
|----------------|------------------------------------------------------------------|
| scr_get        | displays the next available scratch volser from the scratch pool |
| scr_info       | displays information relating to the scratch pool                |
| scr_insert     | inserts a cartridge and adds it to the scratch pool              |
| scr_mount      | places the next available scratch cartridge in the drive         |
| scr_set        | adds cartridges in the AML system to the scratch pool            |
| scr_unset      | changes cartridge status from scratch to unscratch               |

---

---

## Command Description

The following sections provide an in-depth description of DAS commands.

### Change Drive Reservation (allocd)

The **allocd** command changes the reservation status of a drive for a client. See Figure 5-1.

```
dasadmin allocd drive UP|EXUP|FUP|DOWN|FDOWN client
dasadmin all drive UP|EXUP|FUP|DOWN|FDOWN client
```

**Figure 5-1** Syntax of a Generic Allocd Command

See Table 5-5 for a list and an explanation of the parameters for the **allocd** command.

**Table 5-5** Parameters for the Allocd Command

| Parameter                     | Explanation                                                            |                                                                                                           |
|-------------------------------|------------------------------------------------------------------------|-----------------------------------------------------------------------------------------------------------|
| drive                         | drive whose status is to be changed                                    |                                                                                                           |
| UP, FUP, EXUP, DOWN, or FDOWN | new reservation status:                                                |                                                                                                           |
|                               | UP                                                                     | makes a normal reservation                                                                                |
|                               | FUP                                                                    | reserves a drive although it is already (normally) reserved by another client or occupied by another user |
|                               | EXUP                                                                   | makes an exclusive reservation which can only be undone by the client itself or by DAS_SUPERVISOR         |
|                               | DOWN                                                                   | removes the normal status of a reservation                                                                |
| FDOWN                         | removes reservation by another client also when the drive is occupied. |                                                                                                           |
| client                        | name of client under which the reservation is to be made               |                                                                                                           |

This function is used in the management of drives with shared usage. Only one client can use a drive at a time. Mount and dismount commands issued by other clients are rejected. A drive must be released by its previous user before a client can normally use it.



**The drive can only be put in the DOWN status by FDOWN if the drive is occupied.**

Also refer to *Listd* on page 5-31

## Reserve Volsers (allocv)

The **allocv** command reserves the specified volser for a client. See Figure 5-2.

```
dasadmin allocv volserrange UP client |
dasadmin allocv DOWN client
```

**Figure 5-2** Syntax of a Generic Allocv Command

See Table 5-6.

Reservation is only possible if:

- the volser is not already reserved
- the volser is not in use (mounted)

**Table 5-6** Parameters for the Allocv Command

| Parameter   | Explanation                                              |                                                       |
|-------------|----------------------------------------------------------|-------------------------------------------------------|
| volserrange | range of volsers to be reserved                          |                                                       |
| UP, DOWN    | new reservation status:                                  |                                                       |
|             | UP                                                       | reserves the specified volser                         |
|             | DOWN                                                     | removes the reservation of all volsers for the client |
| client      | name of client under which the reservation is to be made |                                                       |



**The reserved volser can only be released by the client itself or the client DAS\_SUPERVISOR. Refer to Figure 5-3 on page 5-9**

```
dasadmin allocv 00012A - 00066B UP DAS_SUPERVISOR
```

**Figure 5-3** Example of the Allocv Command

## ■ Activate/Deactivate the Barcode Reader (barcode)

The **barcode** command activates or deactivates the barcode reader of the specified robotic controller for mount, and eject commands, but only for those commands sent by the DAS to the AMS. See Figure 5-4.

```
dasadmin barcode robotnumber ON|OFF
```

**Figure 5-4** Syntax of a Generic Barcode Command

Barcode reading remains active for inventory and insertion even when barcode reading is deactivated.

See Table 5-7 for a list and explanation of parameters for the **barcode** command.

**Table 5-7** Parameters for the Barcode Command

| Parameter   | Explanation                                                                           |                            |
|-------------|---------------------------------------------------------------------------------------|----------------------------|
| robotnumber | number (R1 or R2) of the robotic controller whose barcode reader is to be deactivated |                            |
| ON, OFF     | new status of barcode reader                                                          |                            |
|             | ON                                                                                    | barcode reader activated   |
|             | OFF                                                                                   | barcode reader deactivated |

See Figure 5-5 for an example of activating the barcode reader for the robotic controller whose *robotnumber* is *R1*.

```
dasadmin barcode ON R1
```

**Figure 5-5** Example of the Barcode Command

---

---

## Cancel Commands (cancel)

The **cancel** command deletes commands from the DAS command queue. See Figure 5-6.

```
dasadmin cancel request-id |
dasadmin can request-id
```

**Figure 5-6** Syntax of a Generic Cancel Commands

See Table 5-8 for the parameter for the cancel command.

**Table 5-8** Parameter for the Cancel Command

| Parameter  | Explanation                                                                                                                   |
|------------|-------------------------------------------------------------------------------------------------------------------------------|
| request-id | DAS sequence number (displayed using the <b>list</b> command) Refer to <i>Display All Active Commands (list)</i> on page 5-25 |

See Figure 5-7 for an example of the **cancel** command.

```
dasadmin can 67
```

**Figure 5-7** Example of the Cancel Command

## Catalog Foreign Volume (catf)

The **catf** command creates the association between the symbolic volser and the slot in the I/O unit.

```
dasadmin catf [-t media-type] volser coordinate
```

**Figure 5-8** Syntax of a Generic Catf Command

Refer to Table 5-9 on page 5-11 for a list and explanations of the parameters of the **catf** command.

**Table 5-9** Parameters for the Catf Command

| Parameter  | Explanation                                                                                                                                      |
|------------|--------------------------------------------------------------------------------------------------------------------------------------------------|
| media-type | media type, e.g. 3590 Refer to <i>Media Types</i> on page A-7                                                                                    |
| volser     | symbolic volser to be assigned to the cartridge in the foreign cartridge range in the I/O unit. A mount command is now possible for this volser. |
| coordinate | 10-digit logical coordinate in the I/O unit locating the cartridge, e.g. E101020310 (Refer to the <i>AMU Reference Manual</i> )                  |

Place the foreign media in the foreign range of the I/O unit. Now set up an assignment to a symbolic volser using the dasadmin **catf** command (not required as a barcode on the cartridge and may already exist as a volser in the database). Place the cartridge in the drive using the **mount** command and the symbolic volser. Remove the cartridge from the I/O unit after use and remove the symbolic volser from the catalog using the **rmf** command.



**This version does not have a command to display occupied symbolic volsers. Make a careful note of this assignment; you will need the symbolic volser again for the rmf command.**

The coordinate in the I/O unit must be defined in the AMU database for the **catf** command

- Attribute           empty
- Type                 foreign

See Figure 5-9 for an example of the **catf** command.

```
dasadmin catf -t 3590 000815 E601010101
```

**Figure 5-9** Example of the Catf Command

Also refer to *Remove a Foreign Medium (rmf)* on page 5-39.

---

---

## Drive Cleaning (clean)

The **clean** command triggers a single drive cleaning operation in the specified drive. See Figure 5-10.

```
dasadmin clean drive
```

**Figure 5-10** Syntax of a Generic Clean Command

See Table 5-10 for the an explanation of the parameter for the **clean** command.

**Table 5-10** Parameter for the Clean Command

| Parameter | Explanation                     |
|-----------|---------------------------------|
| drive     | drive to be cleaned immediately |

The AMS manages the cleaning cartridge and controls the length of time spent by the cleaning cartridge in the drive (Refer to *Clean Manager* in the *AMU Reference Manual*)



**Only clean the drives when they need to be cleaned. Unnecessary cleaning damages the drives.**

See Figure 5-11 for an example of the **clean** command.

```
dasadmin clean Drive6
```

**Figure 5-11** Example of the Clean Command

Also refer to *Insert Media (insert2)* on page 5-21 and *Eject Cleaning Cartridges (ejectcl)* on page 5-17.



---

---

## Retrieve a Medium from the Drive (dismount)

The **dismount** command retrieves a cartridge or optical disk from the drive and returns it to its original position (home position) in the AML. See Figure 5-12.

```
dasadmin dismount [-t media-type] volser | -d drive
dasadmin dismount [-t media-type] volser | -d drive
```

**Figure 5-12** Syntax of a Generic Dismount Command

See Table 5-11 for an explanation of the parameters for the **dismount** command.

**Table 5-11** Parameters for the Dismount Command

| Parameter  | Explanation                                                                |
|------------|----------------------------------------------------------------------------|
| media-type | media type, e.g. 3590. Refer to <i>Media Types</i> on page A-7             |
| volser     | volser for the medium to be returned from the drive to the home position   |
| drive      | alternative parameter for the drive from which the medium is to be removed |

The **dismount** command will not function if the medium has not been unloaded from the drive.



**Retries can be configured in the *config* file or in the AMS configuration.**

See Figure 5-13 for an example of the **dismount** command.

```
dasadmin dismount -t 3590 000815
```

**Figure 5-13** Example of the Dismount Command

Also refer to *Load Cartridge in Drive (mount)* on page 5-34

---

---

## Eject Media (eject2)

The `eject2` command causes the specified volsers to be placed in the I/O unit of the AML system. See Figure 5-14.

```
dasadmin eject2 [-c] [-t media-type] volserrange area
dasadmin ej2 [-c] [-t media-type] volserrange area
```

**Figure 5-14** Syntax of a Generic Eject2 Command

See Table 5-12 for an explanation of the parameters for the `eject` command.

**Table 5-12** Parameters for the Eject2 Command

| Parameter   | Explanation                                                             |
|-------------|-------------------------------------------------------------------------|
| -c          | complete eject option                                                   |
| media-type  | media type, e.g. 3590 Refer to <i>Media Types</i> on page A-7           |
| volserrange | range of volsers to be ejected, e.g. 000001 - 000815 or 00001A, 00002A. |
| area        | logical range in the I/O unit for ejection, e.g. E07                    |

The appropriate message will be displayed in the AMU log if the I/O unit is full. Ejection will continue automatically once the I/O unit has been cleared and closed.

With the environment variable `DAS_EJECTAREAFULL=1` the command will be canceled (with the message `EAREAFULL`), if the eject area is full.

Slots in the AMU database are set, in a complete ejection, as follows

- Volser 0000000000000000
- Attribute empty
- Type unchanged

Slots in the AMU database are set, in a normal (no option) ejection, as follows

- Volser unchanged
- Attribute ejected
- Type unchanged

---

---

This location remains reserved for the ejected volser.

See Figure 5-15 for an example of the **eject** command.

```
dasadmin ej2 -c -t 3590 000001-000005 E02

eject of volser range: 000001-000005, to area: E02
successful
volser 528333 media C0 error 0
volser 528335 media C0 error 0
volser 528341 media C0 error 0
volser 528343 media C0 error 0
volser 528344 media C0 error 0
```

**Figure 5-15** Example of the Eject2 Command

See Table 5-13 for an explanation of the returned status associated with the **eject2** command.

**Table 5-13** Explanation of the Returned Status

| Displa                 | Explanation                                                                               |
|------------------------|-------------------------------------------------------------------------------------------|
| eject of volser range: | volser range from command                                                                 |
| to area:               | eject area from command                                                                   |
| volser                 | volser for the ejected media                                                              |
| media                  | media type as AMS type, e.g. C0. Refer to <i>Media Types</i> on page A-7                  |
| error                  | return code variable d_errno. Refer to <i>Derrno Variable</i> on page 6-99<br>0: no error |

---

---

## Eject Media (eject)

The **eject** command causes the specified volsers to be placed in the I/O unit of the AML system. See Figure 5-16.

```
dasadmin eject [-c] [-t media-type] volserrange area
dasadmin ej [-c] [-t media-type] volserrange area
```

**Figure 5-16** Syntax of a Generic Eject Command

The command can display only a small number of volsers when ejecting. Therefore, use the **eject2** command. For compatibility reasons, the **eject** command continues to be supported.

See Table 5-14 for an explanation of the parameters for the **eject** command.

**Table 5-14** Parameters for the Eject Command

| Parameter   | Explanation                                                             |
|-------------|-------------------------------------------------------------------------|
| -c          | complete eject option                                                   |
| media-type  | media type, e.g. 3590. Refer to <i>Media Types</i> on page A-7          |
| volserrange | range of volsers to be ejected, e.g. 000001 - 000815 or 00001A, 00002A. |
| area        | logical range in the I/O unit for ejection, e.g. E07                    |

The appropriate message will be displayed in the AMU log if the I/O unit is full. Ejection will continue automatically once the I/O unit has been cleared and closed.

With the environment variable `DAS_EJECTAREAFULL=1` the command will canceled (with the message `EAREAFULL`), if the eject area is full.

Slots in the AMU database are set, in a complete ejection, as follows

- Volser 0000000000000000
- Attribute empty
- Type unchanged

Slots in the AMU database are set as follows in a normal (no option) ejection.

- Volser                    unchanged
- Attribute                ejected
- Type                      unchanged

This location remains reserved for the ejected volser.

See Figure 5-17 for an example of the **eject** command.

```
dasadmin eject GR3101-GR3143 E01

eject of volser range: GR3101-GR3143, to area: E01
successful
```

**Figure 5-17** Example of the Eject Command

## Eject Cleaning Cartridges (ejectcl)

The **ejectcl** command causes the AMS Clean Manager to eject all used cleaning cartridges in the specified clean pool. See Figure 5-18.

```
dasadmin ejectcl cleanpool area
```

**Figure 5-18** Syntax of a Generic Ejectcl Command

See Table 5-15 for an explanation of the parameters for the **ejectcl** command.

**Table 5-15** Parameters for the Eject Command

| Parameter | Explanation                                                            |
|-----------|------------------------------------------------------------------------|
| cleanpool | name for assigning cleaning cartridges for the Clean Manager, e.g. P04 |
| area      | logical range in the I/O unit for ejection, e.g. E07                   |

The appropriate message will be displayed in the AMU log if the I/O unit is full. Ejection will continue automatically once the I/O unit has been cleared and closed.

With the environment variable `DAS_EJECTAREAFULL=1` the command will be canceled (with the message `EAREAFULL`), if the eject area is full.

---

---

Slots in the AMU database are set, in ejection, as follows:

- Volser                    0000000000000000
- Attribute                empty
- Type                     AMU Dynamic

See Figure 5-19 for an example of the **ejectcl** command.

```
dasadmin ejectcl P04 E04
```

**Figure 5-19** Example of the Ejectcl command

## Flip Optical Disk in the Drive (flip)

The **flip** command turns an optical disk over so that the reverse side can be read or written to. See Figure 5-20.

```
dasadmin flip drive
```

**Figure 5-20** Syntax of a Generic Flip Command

See Table 5-16 for an explanation of the parameter for the **flip** command.

**Table 5-16** Parameters for the Flip Command

| Parameter | Explanation                                          |
|-----------|------------------------------------------------------|
| drive     | drive of the optical disk to be flipped, e.g. Drive1 |

See Figure 5-21 for an example of the **flip** command.

```
dasadmin flip Drive1
```

**Figure 5-21** Example of the Flip Command

---

---

## Display Volsers for Drive (getvolsertodrive)

The `getvolsertodrive` command displays a list of all volsers assigned to the drive. See Figure 5-22.

```
dasadmin getvolsertodrive [drive]
```

**Figure 5-22** Syntax of Generic Getvolsertodrive Command

The assignment will be configured in the *config* file. Refer to *Configuration File* on page 4-10. See Table 5-17 for an explanation of the parameters for the `getvolsertodrive`.

**Table 5-17** Parameters for the Getvolsertodrive Command

| Parameter | Explanation                                          |
|-----------|------------------------------------------------------|
| drive     | Drive whose volsers are to be displayed, e.g. Drive1 |

See Figure 5-23 for an example of the `getvolsertodrive` command.

```
dasadmin getvolsertodrive Drive1

getvolsertodrive successful
Drive: D01 volser-range: 000001, 000004-000999
```

**Figure 5-23** Example of the Getvolsertodrive

---

---

## Assign Volsers to an Optical Disk (getvoltside)

The **getvoltside** command displays both volsers for an optical disk. See Figure 5-24.

```
dasadmin getvoltside volser
```

**Figure 5-24** Syntax of a Generic Getvoltside Command

See Table 5-18 for an explanation of the parameter for the **getvoltside** command.

**Table 5-18** Parameter for the Getvoltside Command

| Parameter | Explanation                                                                                |
|-----------|--------------------------------------------------------------------------------------------|
| volser    | one of the volsers for the optical disk, the associated sides of which are to be displayed |

See Figure 5-24 for example of the **getvoltside** command.

```
dasadmin getvoltside 000815B
```

```
A-side: 000815A
```

```
B-side: 000815B
```

**Figure 5-25** Example of the Getvoltside Command



---

---

## Insert Media (insert2)

The **insert2** command causes the AMS to place all media in the specified insertion range in slots in the AML. The volsers of the inserted media are displayed. See Figure 5-26.

```
dasadmin insert2 -n area
dasadmin insert2 -c area cleanpool
```

**Figure 5-26** Syntax of a Generic Insert2 Command

See Table 5-19 for an explanation of the parameters for the **insert** command.

**Table 5-19** Parameters for the Insert Command

| Parameter | Explanation                                                              |
|-----------|--------------------------------------------------------------------------|
| -n        | normal insertion (data media)                                            |
| -c        | inserts cleaning cartridges                                              |
| area      | logical range in the I/O unit for inserting media, e.g. I01              |
| cleanpool | name for assigning cleaning cartridges for the Clean Manager, e.g. CLP04 |

Place the media in the I/O unit in the logical range for insertion before starting the **insert** command (Refer to the *AMU Reference Manual*). AMS will analyse changes in the I/O unit automatically once the I/O unit has been closed. The **insert** command can be used to:

- return a known volser in the AMU database to its home position, independent of the attributes (ejected, empty, occupied, mounted) of the slot; the barcode reader recognizes a volser which is already entered in the AMU database.
- place an unknown volser in the next free slot; this depends on the existence in the AMU database of slots of the relevant media type having the status
  - Volser           0000000000000000
  - Attribute       empty
  - Type            AMU Dynamic

- place a medium in the problem box if it is not suitable for insertion at present
  - illegible barcode
  - AML full
  - slots in the AML already reserved for other volsers

Figure 5-27 shows an example of the insert2 command when inserting a cleaning cartridge.

```
dasadmin insert2 -c I01 P01
```

**Figure 5-27** Example of the Insert2 Command

The output of the insert2 command indicates which volser(s) were successfully inserted and which, if any, were not.

## Insert Media (insert)

The **insert** command causes the AMS to place all media in the specified insertion range at slots in the AML. The volsers of the inserted media are displayed. See Figure 5-28.

```
dasadmin insert area
dasadmin in area
```

**Figure 5-28** Syntax of a Generic Insert Command

See Table 5-20 for an explanation of the parameters for the **insert** command.

**Table 5-20** Parameter for the Insert Command

| Parameter | Explanation                                                 |
|-----------|-------------------------------------------------------------|
| area      | logical range in the I/O unit for inserting media, e.g. I01 |

Place the media in the I/O unit in the logical range for insertion before issuing the **insert** command (Refer to the *AMU Reference Manual*). AMS analyses changes in the I/O automatically once the I/O unit has been closed. The **insert** command can be use to:

- return a known volser in the AMU database to its home position, independent of the attributes (ejected, empty, occupied, mounted) of the slot; the barcode reader recognizes a volser which is already entered in the AMU database.
- place an unknown volser in the next free slot; this depends on the existence in the AMU database of slots of the relevant media type having the status
  - Volser           0000000000000000
  - Attribute       empty
  - Type            AMU Dynamic
- place a medium in the problem box if it is not suitable for insertion at present
  - illegible barcode
  - AML full
  - slots in the AML already reserved for other volsers



Use the `insert2` command instead of this command. This command experiences difficulties with large I/O units with long volsers (16-digit) since the buffer for displaying the inserted volser is restricted. For compatibility reasons, the `insert` command continues to be supported.

## Compare Volsers in the AML (inventory)

The `inventory` command causes the AML system to compare all slots (towers and racks) with the entries in the AMU database and to update the AMU database in the event of any variances. See Figure 5-29.

```
dasadmin inventory
```

**Figure 5-29** Syntax of a Generic Inventory command.

Empty slots with the ejected or mounted attribute are not modified.

The volser will be overwritten by a symbolic volser, e.g. \*I0001, if the barcode is illegible.

DAS sends an acknowledgment for this command.



## Warning

The inventory function is intended for testing and startup. An error function will only be displayed in the AMU log during operation (and not returned to the calling process). The entire database will be overwritten with a symbolic volser “\*Ixxx” if the barcode reader malfunctions.

Also refer to *Display All Active Commands (list)* on page 5-25, and *Compare Volser Ranges (PartInventory)* on page 5-35

## Shut Down the AMU PC (killamu)

The **killamu** command is used to:

- move the robotic controllers in the AML system to their home position
- shut down all programs on the AMU PC
- shut down the OS/2 operating system

See Figure 5-30 for the syntax of the **killamu** command.

```
dasadmin killamu
```

Figure 5-30 Syntax of the Killamu Command



## Warning

Inform all administrators using the AML system before starting the command. The command may cause disruption to their operation.

DAS sends a positive acknowledgment, before the process is complete. Wait at least 5 minutes following the positive acknowledgment before switching off the power supply. Switching off the power supply to the AMU PC too soon can lead to loss of data.



Restart the AMU kernel with `START KRN/S`.

---

---

## Display All Active Commands (list)

The **list** command displays all commands in the DAS command queue. The commands for one client only are displayed. See Figure 5-31.

```
dasadmin list client
```

**Figure 5-31** Syntax of a Generic a List Command

See Table 5-21 for an explanation of the parameter for the **list** command.

**Table 5-21** Parameters for the List Command

| Parameter | Explanation                                               |
|-----------|-----------------------------------------------------------|
| client    | client for which the active commands are to be displayed. |

See Figure 5-32 for an example of the **list** command.

```
dasadmin list AMUCLIENT

list for client: AMUCLIENT successful
client = AMUCLIENT
 request = 1
 individ_no = 0
 type = PINV
client = AMUCLIENT
 request = 7
 individ_no = 0
 type = MONT
```

**Figure 5-32** Example of the List Command

Refer to Table 5-22 on page 5-26 for an explanation of the return status associated with the **list** command.

---

---

**Table 5-22** Explanation of Returned Status

| <b>Displa</b> | <b>Explanation</b>                                        |                         |
|---------------|-----------------------------------------------------------|-------------------------|
| client        | client for which the active commands are to be displayed. |                         |
| request       | sequence number of the DAS commands                       |                         |
| individ_no    | not used                                                  |                         |
| type          | MONT                                                      | mount command           |
|               | KEEP                                                      | dismount command        |
|               | INVT                                                      | insert command          |
|               | MOVE                                                      | eject command           |
|               | PINV                                                      | inventory command       |
|               | SHUT                                                      | AMU shut down (killamu) |
|               | INCL                                                      | Insert Clean            |
|               | EJCL                                                      | Eject Clean             |
|               | BACO                                                      | Barcode on/off          |

Also refer to *Cancel Commands (cancel)* on page 5-10.

---

---

## Display Drive Assignment

This section describes the **listd3**, **listd2** and **listd** commands. For compatibility reasons **listd2** and **listd** are shell supported.

### Listd3

The **listd3** command displays the current drive assignment and status of reservations by the clients. All drives (maximum of 250) will be displayed if a client is not specified. See Figure 5-33.

```
dasadmin listd3 [clientname]
```

**Figure 5-33** Syntax of a Generic Listd3 Command

See Table 5-25 for an explanation of the parameter for the **listd3** command.

**Table 5-23** Parameter for the Listd3 Command

| Parameter  | Explanation                                               |
|------------|-----------------------------------------------------------|
| clientname | client for which the reserved drives are to be displayed. |

Refer to Figure 5-34 on page 5-28 for an example of the **listd3** command.

```

listd for client: successful
drive: Drive1
amu drive: 01
st: UP
type: 2
sysid:
client: AMUCLIENT
volser:
mount: 0
keep: 0
cleaning 0
clean_count: 0
drive: OD512
amu drive: 02
st: UP
type: H
sysid:
client: AMUCLIENT
volser: OD0001
mount: 0
keep: 0
cleaning 0
clean_count: 6

```

**Figure 5-34** Example of the Listd3 Command

See Table 5-24 for an explanation of the return status associated with the **listd3** command.

**Table 5-24** Explanation of Return Status

| Display    | Explanation                                                               |
|------------|---------------------------------------------------------------------------|
| drive:     | name of the drive in DAS ( <i>Description</i> from the AMS configuration) |
| amu drive: | number of the drive in the DAS ( <i>Name</i> from the AMS configuration)  |
| st:        | reservation status of the drive                                           |
| type:      | drive type ( <i>Type</i> from the AMS configuration)                      |
| sysid:     | not used                                                                  |
| client:    | client which has reserved the drive                                       |



**Table 5-24** Explanation of Return Status

| Displa      | Explanation                                                                                                                         |
|-------------|-------------------------------------------------------------------------------------------------------------------------------------|
| volers:     | volser, if the drive is currently occupied                                                                                          |
| mount:      | if a volser is displayed, and mount=1 and keep=0 then the drive is logically occupied but the mount is not physically complete      |
|             | if a volser is displayed, and mount=0 and keep=0, then the drive is logically occupied and mount is physically complete             |
| keep:       | if a volser is not displayed, and mount=0 and keep=1, then the drive is logically empty but the keep may not be physically complete |
|             | if a volser is not displayed, and mount=0 and keep=0 then the drive is logically empty and the keep is physically complete          |
| cleaning    | current cleaning activity                                                                                                           |
|             | 0   drive is not being cleaned                                                                                                      |
|             | 1   cleaning medium is located in the drive                                                                                         |
| clean_count | number of mount commands until the next drive clean                                                                                 |

The mount and keep parameters are new in the listd3 command.

## Listd2

The **listd2** command displays the current drive assignment and status of reservations by the clients. All drives (maximum of 250) will be displayed if a client is not specified. See Figure 5-35.

```
dasadmin listd2 [client]
dasadmin ld2 [client]
```

**Figure 5-35** Syntax of a Generic Listd2 Command.

Refer to Table 5-25 on page 5-30 for an explanation of the parameter for the **listd2** command.

**Table 5-25** Parameter for the Listd2 Command

| Parameter | Explanation                                               |
|-----------|-----------------------------------------------------------|
| client    | client for which the reserved drives are to be displayed. |

The command accesses the:

- AMU database for the drive assignment,
- the AMS configuration for the drive type and
- the *dasdata.ini* file for the reservation status of the drive.

See Figure 5-36 for an example of the **Listd2** command.

```
dasadmin ld2

listd for client: successful
drive dlt01 amu drive: 01 st: DOWN type: E sysid: client:
volser: cleaning 0 clean_count: 0
drive: vhs01 amu drive: 02 st: DOWN type: V sysid:
client: volser: cleaning 0 clean_count: 0
drive: lms01 amu drive: 03 st: UP type: Q sysid:
client: AMUCLIENT volser: 000026 cleaning 0
clean_count: 21
drive: dat01 amu drive: 04 st: UP type: F sysid:
client: AMUCLIENT volser: cleaning 0 clean_count: 26
```

**Figure 5-36** Example of the Listd2 Command

See Table 5-26 for an explanation of the return status associated with the **listd2** command.

**Table 5-26** Explanation of Returned Status

| Displa     | Explanation                                                               |
|------------|---------------------------------------------------------------------------|
| drive:     | name of the drive in DAS ( <i>Description</i> from the AMS configuration) |
| amu drive: | number of the drive in DAS ( <i>Name</i> from the AMS configuration)      |
| st:        | reservation status of the drive                                           |

**Table 5-26** Explanation of Returned Status

| Displa       | Explanation                                          |                                         |
|--------------|------------------------------------------------------|-----------------------------------------|
| type:        | drive type ( <i>Type</i> from the AMS configuration) |                                         |
| sysid:       | not used                                             |                                         |
| client:      | client which has reserved the drive                  |                                         |
| volser:      | volser, if the drive is occupied at present          |                                         |
| cleaning:    | current cleaning activity                            |                                         |
|              | 0                                                    | drive is not being cleaned              |
|              | 1                                                    | cleaning medium is located in the drive |
| clean_count: | number of mount commands until the next drive clean  |                                         |



The maximum number of drives displayed is 250.

## Listd

The **listd** command displays the current drive assignment and status of reservations by the clients. All drives (maximum of 15) will be displayed if a client is not specified.

```
dasadmin listd [client]
dasadmin ld [client]
```

**Figure 5-37** Syntax of a Generic Listd Command

Refer to Table 5-27 on page 5-31 for an explanation of the parameter for the **listd** command.

**Table 5-27** Parameter for the Listd Command

| Parameter | Explanation                                               |
|-----------|-----------------------------------------------------------|
| client    | client for which the reserved drives are to be displayed. |

Refer to Figure 5-25 on page 5-20 for an example of the listd command.

```

dasadmin listd

listd for client: successful
drive dlt01 amu drive: 01 st: DOWN type: E sysid: client:
volser: cleaning 0 clean_count: 0
drive: vhs01 amu drive: 02 st: DOWN type: V sysid:
client: volser: cleaning 0 clean_count: 0
drive: lms01 amu drive: 03 st: UP type: Q sysid: client
AMUCLIENT volser: 000026 cleaning 0 clean_count: 21
drive: dat01 amu drive: 04 st: UP type: F sysid:
client: AMUCLIENT volser: cleaning 0 clean_count: 26

```

**Figure 5-38** Example of the Listd Command

See Table 5-28 for an explanation of the parameter for the **listd** command.

**Table 5-28** Explanation of the Return Status

| Displa       | Explanation                                                               |                                         |
|--------------|---------------------------------------------------------------------------|-----------------------------------------|
| drive:       | name of the drive in DAS ( <i>Description</i> from the AMS configuration) |                                         |
| amu drive:   | number of the drive in DAS ( <i>Name</i> from the AMS configuration)      |                                         |
| st:          | reservation status of the drive ( <i>dasdata.ini</i> )                    |                                         |
| type:        | drive type ( <i>Type</i> from the AMS configuration)                      |                                         |
| sysid:       | not used                                                                  |                                         |
| client:      | client which has reserved the drive                                       |                                         |
| volser:      | volser, if the drive is occupied at present                               |                                         |
| cleaning:    | current cleaning activity                                                 |                                         |
|              | 0                                                                         | drive is not being cleaned              |
|              | 1                                                                         | cleaning medium is located in the drive |
| clean_count: | number of mount commands until the next drive clean                       |                                         |



**The maximum number of drives displayed is 15.**

---

---

## Display Volser Reservation (listv)

The **listv** command displays all reserved volsers for the client. All reserved volsers for all clients will be displayed if no client is specified. See Figure 5-39.

```
dasadmin listv [client]
```

**Figure 5-39** Syntax of a Generic Listv Command

See Table 5-29 for an explanation of the parameter for the **listv** command.

**Table 5-29** Parameter for the Listv Command

| Parameter | Explanation                                                |
|-----------|------------------------------------------------------------|
| client    | client for which the reserved volsers are to be displayed. |

See Figure 5-40 for an example of the **listv** command.

```
dasadmin listv POST

listv successful
client: POST volser-range: 123456,123457 status: UP
```

**Figure 5-40** Example of the Listv Command

---

---

## Load Cartridge in Drive (mount)

The **mount** command places the medium with the specified volser in a drive. The drive can be specified or will be selected by DAS such that

- it is suitable for the media type
- it is reserved for the executing client (**allocd**)
- it has the least number of uses (*Use Count* AMU database value).

See Figure 5-41 for an example of the **mount** command.

```
dasadmin mount [-t media-type] volser [drive]
dasadmin mo [-t media-type] volser [drive]
```

**Figure 5-41** Syntax of a Generic Mount Command

See Table 5-30 for an explanation of the parameters for the **mount** command.

**Table 5-30** Parameters for the Mount Command

| Parameter  | Explanation                                                                                                                                                                                            |
|------------|--------------------------------------------------------------------------------------------------------------------------------------------------------------------------------------------------------|
| media-type | media type, e.g. B. 3590. Refer to <i>Media Types</i> on page A-7                                                                                                                                      |
| volser     | volser for the medium to be placed in a drive (also symbolic volsers for foreign mount)                                                                                                                |
| drive      | name of the drive (AMS description) for the <b>mount</b> command. The parameter can be omitted if the reservation or media type make the drive clear or if the drive with the least use is to be used. |



**The drive used for the command will not be returned.**

See Figure 5-42 for an example of the **mount** command.

```
dasadmin mount -t DECDLT A00815
```

**Figure 5-42** Example of the Mount Command

---

---

## Compare Volser Ranges (PartInventory)

The **PartInventory** command causes the AML system to compare the specified slots (towers and racks) with the entries in the AMU database and to update the AMU database in the event of any variances. See Figure 5-43.

```
dasadmin PartInventory [sourcecoor] [targetcoor]
dasadmin pinvt [sourcecoor] [targetcoor]
```

**Figure 5-43** Syntax of a Generic PartInventory Command

See Table 5-31 for an explanation of the parameters for the **PartInventory** command.

**Table 5-31** Parameters for the PartInventory Command

| Parameter  | Explanation                                                                                                                                                |
|------------|------------------------------------------------------------------------------------------------------------------------------------------------------------|
| sourcecoor | logical coordinates in the AML at which the inventory is to begin, e.g. T104320908                                                                         |
| targetcoor | last slot in the inventory, e.g. T105010310. This slot must be in the same components (storage tower, rack etc.) as those specified in <i>sourcecoor</i> . |

Empty slots with the ejected or mounted attribute are not modified.

The volser will be overwritten by a symbolic volser, e.g. \*I0001, if the barcode is illegible.

### **Warning**

**The PartInventory function is intended for testing and start-up. An error function will only be displayed in the AMU log during operation (and not returned to the calling process). The entire database will be overwritten with a symbolic volser “\*Ixxxx” if the barcode reader malfunctions.**

See Figure 5-44 for an example of the **PartInventory** command.

```
dasadmin pinvt T104320908 T105010310
```

**Figure 5-44** Example of the PartInventory Command

---

---

Also refer to *Compare Volsers in the AML (inventory)* on page 5-23

## Query the Software Version (qversion)

The **qversion** command displays the version of:

- DAS software (server on OS/2)
- ACI software (on the local platform)

See Figure 5-45 for an example of the **qversion** command.

```
dasadmin qversion
```

**Figure 5-45** Example of a Generic qversion Command

See Figure 5-46 for an example of the **qversion** command.

```
dasadmin qversion

ACI version : 3.01
DAS version : 3.01
```

**Figure 5-46** Example of the qversion Command

## Query the Volser Ranges in the AML (qvolsrange)

The **qvolsrange** command causes an AMU database query for a specified volser range. See Figure 5-47.

```
dasadmin qvolsrange beginvolser endvolser count
[client]
```

**Figure 5-47** Syntax of a Generic qvolsrange Command

Refer to Table 5-32 on page 5-37 for an explanation of the parameters for the **qvolsrange** command.



**Table 5-32** Parameters for the qvolrange Command

| Parameter   | Explanation                                                                                 |
|-------------|---------------------------------------------------------------------------------------------|
| beginvolser | first volser in the range to be displayed. Enter to obtain a less precisely specified query |
| endvolser   | last volser in the range to be displayed. Enter to obtain a less precisely specified query  |
| count:      | number of volsers to be displayed                                                           |
| client      | optional parameter to specify the volsers for a client other than the local one             |

See Figure 5-48 for an example of the **qvolrange** command.

```
dasadmin qvolrange 000001 000200 100
```

**Figure 5-48** Example of the qvolrange Command

```
dasadmin qvolrange 0000018 999999 5

next volser 000368
count 5
more data
volser 000018 media 3480 attrib Occupied
volser 000025 media 3480 attrib Occupied
volser 000026 media 3480 attrib Mounted
volser 000079 media 3480 attrib Occupied
volser 000083 media 3480 attrib Occupied
```

**Figure 5-49** Example of Return Status

Refer to Table 5-33 on page 5-38 for an explanation of the return status.

---

---

**Table 5-33** Explanation of Return Status

| <b>Displa</b> | <b>Explanation</b>                                                                                                                                                                                                                                                                                                                                                                     |
|---------------|----------------------------------------------------------------------------------------------------------------------------------------------------------------------------------------------------------------------------------------------------------------------------------------------------------------------------------------------------------------------------------------|
| next volser   | next volser belonging to the range which cannot be displayed at present (count)                                                                                                                                                                                                                                                                                                        |
| count:        | number of volser to be displayed, limited by count parameter in the command                                                                                                                                                                                                                                                                                                            |
| more data     | not all volsers are represented by the specified range                                                                                                                                                                                                                                                                                                                                 |
| volser        | 1- to 16-digit volume serial number                                                                                                                                                                                                                                                                                                                                                    |
| media         | media type for the coordinates belonging to the volser, e.g. z. B. 3590. Refer to <i>Media Types</i> on page A-7                                                                                                                                                                                                                                                                       |
| attrib        | attributes of the coordinates belonging to the volser (Refer to the <i>AMU Reference Manual</i> ) <ul style="list-style-type: none"><li>• Occupied</li><li>• Mounted</li><li>• Ejected</li><li>• Empty</li><li>• Reverse Side Mounted</li><li>• In Jukebox</li><li>• Initial</li><li>• Temp Here</li><li>• Temp Away</li><li>• Undefined (all other AMU database attributes)</li></ul> |

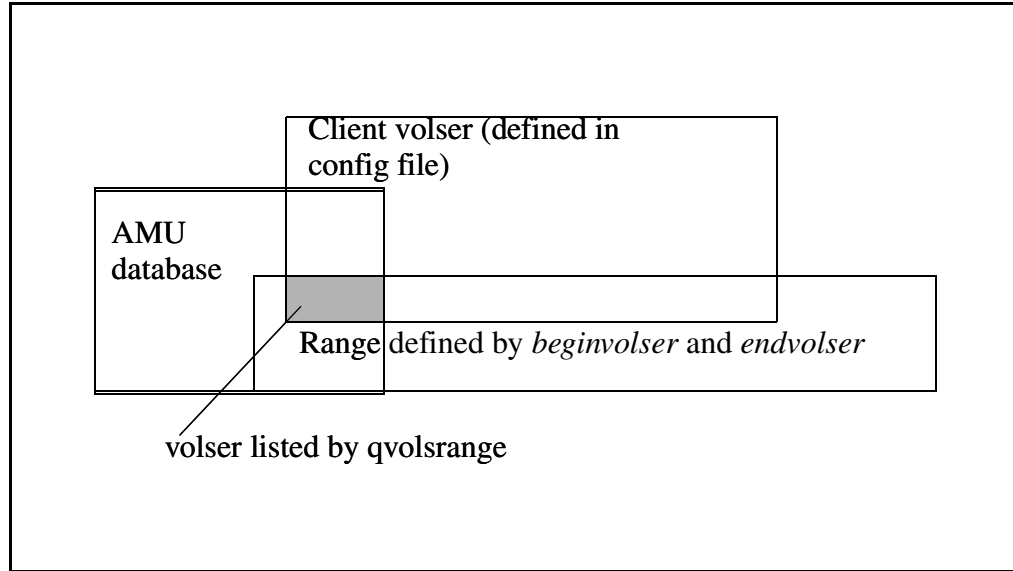

**Figure 5-50** Selection of Volsers Displayed

## Remove a Foreign Medium (rmf)

The **rmf** command removes a link between a symbolic volser and a slot in the I/O unit. See Figure 5-51.

```
dasadmin rmf [-t media-type] volser coordinate
```

**Figure 5-51** Syntax of a Generic Rmf Command

See Table 5-34 for an explanation of the parameters for the **rmf** command.

**Table 5-34** Parameters for the Rmf Command

| Parameter  | Explanation                                                                                                                     |
|------------|---------------------------------------------------------------------------------------------------------------------------------|
| media-type | e.g. 3590. Refer to <i>Media Types</i> on page A-7                                                                              |
| volser     | symbolic volser assigned to the cartridge in the foreign cartridge range of the I/O unit.                                       |
| coordinate | 10-digit logical coordinate in the I/O unit locating the cartridge, e.g. E101020310 (Refer to the <i>AMU Reference Manual</i> ) |

---

---

See Figure 5-52 for an example of the **rmf** command.

```
dasadmin rmf -t DECDLT 32168 E701010209
```

**Figure 5-52** Example of the Rmf Command

Also refer to *Catalog Foreign Volume (catf)* on page 5-10

## ■ Deactivate Robotic Controller in the AML (robhome)

The **robhome** command moves the robotic controller (robotic controller 1 or 2 in the case of AML/2) to its home position and sets its status to *inactive*. All further commands from all other host systems to this robotic controller are acknowledged negatively (AMU message: The desired robot is not available <1138>). The robotic controller can be reset to *active* using the **robstat** command. See Figure 5-53.

```
dasadmin robhome robotnumber
```

**Figure 5-53** Syntax of a Generic Robhome Command

See Table 5-35 for an explanation of the parameters for the **robhome** command.

**Table 5-35** Parameter for the Robhome Command

| Parameter   | Explanation                                                        |
|-------------|--------------------------------------------------------------------|
| robotnumber | number (R1 or R2) of the robotic controller to be set to inactive. |

See Figure 5-54 for an example of the **robhome** command.

```
dasadmin robhome R1
```

**Figure 5-54** Example of the Robhome Command

---

---

## Activate Robotic Controller in the AML (robstat)

The **robstat** command can either change the status of the robot (online/offline) or display the actual status on the screen. See Figure 5-54.

```
dasadmin robstat [robotnumber] action
```

**Figure 5-55** Syntax of a Generic Robstat Command



### Note

The parameters for the **robstat** command are not case sensitive.

See Table 5-36 for an explanation of the parameters for the **robstat** command.

**Table 5-36** Parameters for the Robstat Command

| Parameter   | Explanation                                                      |                                                                   |
|-------------|------------------------------------------------------------------|-------------------------------------------------------------------|
| robotnumber | number (R1 or R2) of the robotic controller to be set to active. |                                                                   |
| action      | START                                                            | sets the robotic controller defined by the robot number to active |
|             | STAT                                                             | queries the status of the robotic controller                      |

See Figure 5-56 for an example of a **robstat** command.

```
dasadmin robstat R1 START
```

**Figure 5-56** Example of the Robstat Command

See Figure 5-57 for an example of the returned output.

```
dasadmin robstat STAT

cmd robstat stat
RobStat 1: NOTREADY, RobStat 2: READY
```

**Figure 5-57** Example of Return Status

---

---

## Set Access Privileges (scap)

Access privileges can be temporarily changed or additional temporary clients can be added using the **scap** command. A maximum of one range can be changed using the **scap** command. See Figure 5-58.

```
dasadmin scap [\pm] [-t media-type] [-d drive-range] |
[-v volser-range] client
```

**Figure 5-58** Syntax of a Generic Scap Command

See Table 5-37 for an explanation of the parameters for the **scap** command.

**Table 5-37** Parameters for the Scap Command

| Parameter    | Explanation                                                                                              |
|--------------|----------------------------------------------------------------------------------------------------------|
| $\pm$        | determines whether the specified range is to be added or removed. The range is added without and with +. |
| media-type   | media type, e.g. 3590. Refer to <i>Media Types</i> on page A-7                                           |
| drive-range  | drives for which client access is to be changed, e.g. DLT01 - DLT16.                                     |
| volser-range | volser range for which client access is to be changed, e.g. 00001 - 99999                                |
| client       | the client for which the changes apply                                                                   |



**The changes will be lost when the DAS software is shut down. Only use this command if, at the time, you do not have access to the configuration *config* file, or you cannot restart DAS. Otherwise, you should always change the access privileges in the *config* file.**

Make sure that the range specified does not overlap with an existing range. If, for example, the range 1 - 100 already exists and the range 5 - 20 is to be excluded, the range 1 - 100 must be excluded, then create new access to the ranges 1 - 4 and 21 - 100. DAS rejects all changes that do not correspond to existing ranges. Refer to Figure 5-59 on page 5-43 for an example of the **scap** command.

```
dasadmin scap + -t 3590 -v (A00001 - A99999) client1
```

Figure 5-59 Example of the Scap Command

## Set Operating Parameters (scop)

The **scop** command makes temporary changes to the DAS operating parameters. See Figure 5-60.

```
dasadmin scop [\pm avc] [\pm c] [\pm dism] [ip-address]
[\pm] client
```

Figure 5-60 Syntax of a Generic Scop Command

See Table 5-38 for an explanation of the parameters for the **scop** Command.

Table 5-38 Parameters for the Scop Command

| Parameter   | Explanation                                                                                                                                                                                                                                                                                |
|-------------|--------------------------------------------------------------------------------------------------------------------------------------------------------------------------------------------------------------------------------------------------------------------------------------------|
| $\pm$ avc   | changes the optional Avoid volume contention parameter (wait for dismount); the default is <b>-avc</b> if the parameter is not specified.                                                                                                                                                  |
| $\pm$ c     | changes the access privileges (restricted or complete); the default is restricted privilege only (-c).                                                                                                                                                                                     |
| $\pm$ dism  | changes the optional dismount parameter (automatic dismount for the subsequent dismount); the default is <b>+dism</b> (no automatic dismount).                                                                                                                                             |
| ip-address  | temporarily changes the client's authorized IP address; the address must be specified in the form <i>xxx.xxx.xxx.xxx</i> , e.g. 192.131.23.10 or as an internet hostname. The parameter must be specified with the first <b>scop</b> command or in the event of changes to the IP address. |
| O.S. client | specifies the client to which the changes refer:<br>+ access privileges assigned to new client<br>- access privileges withdrawn from client<br>access privileges or operating parameters of an existing client are changed if $\pm$ is omitted                                             |



## Warning

The changes will be lost when the DAS software is shut down. Only use this command if, at the time, you do not have access to the *config* file, or you cannot restart the DAS. Otherwise, you should always change the access privileges in the *config* file.

See Figure 5-61 for an example of the **scop** command.

```
dasadmin +avc +c +dism inetsevr DAS_SUPERVISOR
```

**Figure 5-61** Example of the Scop Command

## Next Scratch Medium (**scr\_get**)

The **scr\_get** command queries the next available scratch medium and sets it to unscratch. See Figure 5-62.

```
dasadmin scr_get [poolname] [-t media-type]
```

**Figure 5-62** Syntax of a Generic Scr\_get Command

Media from the default pool are called by specifying the media type, without a poolname. See Table 5-39 for an explanation of the parameters for the **scr\_get** command.

**Table 5-39** Parameters for the Scr\_get Command

| Parameter  | Explanation                                                                                           |
|------------|-------------------------------------------------------------------------------------------------------|
| poolname   | specification of the pool name in the AMU database from which the scratch medium is to be taken.      |
| media-type | media type, e.g. 3590. Refer to <i>Media Types</i> on page A-7 of which a scratch medium is required. |

See Figure 5-63 for an example of the **scr\_get** command.

```
dasadmin scr_get -t 3590
```

**Figure 5-63** Example of the Scr\_get command



---

---

## Scratch Pool Information (**scr\_info**)

The **scr\_info** command provides information on the current stock of scratch media in the scratch pools. See Figure 5-64.

```
dasadmin scr_info [poolname] [-t media-type]
```

**Figure 5-64** Syntax of a Generic Scr\_info Command

Information on the default scratch pool can be obtained by specifying the media type without the pool name. See Table 5-40 for an explanation of the parameters for the **scr\_info** command.

**Table 5-40** Parameters for the Scr\_info Command

| Parameter  | Explanation                                                                                                                  |
|------------|------------------------------------------------------------------------------------------------------------------------------|
| poolname   | specifies the pool name in the AMU database from which information on the scratch media is to be displayed.                  |
| media-type | media type, e.g. 3590. Refer to <i>Media Types</i> on page A-7 for the default pool of which information is to be displayed. |

This command displays the number of media in the pool and the number of scratch media in the pool. See Figure 5-65 for an example of the **scr\_info** command.

```
dasadmin scr_info -t 3590

DEFAULT_POOL: VolserCount: 23, ScratchCount: 12
```

**Figure 5-65** Example of the Scr\_info Command

---

---

## Insert Scratch Media (scr\_insert)

The `scr_insert` command inserts the media from the insertion range of the media specified and sets them to scratch in the AMU database (`insert` and `set_scr` commands). See Figure 5-66.

```
dasadmin scr_insert [-p poolname] [-t media-type] area
```

**Figure 5-66** Syntax of a Generic Scr\_insert Command



**Data stored on your media may be lost. This command automatically sets all media (without confirmation prompt) inserted in the AML system in the insertion range specified to scratch media. The data on the data medium is overwritten by the next scratch mount command.**

DAS automatically uses the default pool for the inserted scratch media if the pool name is not specified. See Table 5-41 for an explanation of the parameters for the `scr_insert` command.

**Table 5-41** Parameters for the Scr\_insert Command

| Parameter  | Explanation                                                                                                              |
|------------|--------------------------------------------------------------------------------------------------------------------------|
| poolname   | specifies the pool name in the AMU database to which the media are to be added.                                          |
| media-type | media type, e.g. 3590. Refer to <i>Media Types</i> on page A-7 into the default pool of which the media are to be added. |
| area       | logical insertion range in the I/O unit from which the scratch media are to be inserted, e.g. I03                        |

See Figure 5-67 for an example of the `scr_insert` command.

```
dasadmin scr_insert -p privat I03
```

**Figure 5-67** Example of the Scr\_insert Command

---

---

## Execute Scratch Mount (**scr\_mount**)

The **scr\_mount** command places a scratch medium from the specified pool (pool name or default) into the specified drive (**scr\_get** and **mount** commands).

```
dasadmin scr_mount [-p poolname] [-t media-type] [drive]
```

**Figure 5-68** Syntax of a Generic Scr-mount Command

DAS automatically uses the default pool for the media type specified if the pool name is not defined. See Table 5-42 for an explanation of the parameters for the **scr\_mount** command.

**Table 5-42** Parameters for the Scr\_mount Command

| Parameter  | Explanation                                                                                                                                                                                            |
|------------|--------------------------------------------------------------------------------------------------------------------------------------------------------------------------------------------------------|
| poolname   | specifies the pool name in the AMU database from which the media are to be taken.                                                                                                                      |
| media-type | media type, e.g. 3590. Refer to <i>Media Types</i> on page A-7 from the default pool of which the media are to be taken.                                                                               |
| drive      | name of the drive (AMS description) for the <b>mount</b> command. The parameter can be omitted if the reservation or media type make the drive clear or if the drive with the least use is to be used. |

The command displays the volser of the scratch cartridge placed into the drive. See Figure 5-69 for an example of the **scr\_mount** command.

```
dasadmin scr_mount -p private drive1
```

**Figure 5-69** Example of the Scr\_mount Command

---

---

## Add Media to the Scratch Pool (scr\_set)

The `scr_set` command adds a volser to a scratch pool in the AMU database. This makes scratch media available for subsequent `scr_get` and `scr_mount` commands.

```
dasadmin scr_set [poolname] [-t media-type] volser
```

**Figure 5-70** Syntax of a Generic Scr\_set Command



### **Attention**

**Data stored on your media may be lost. This command automatically sets the specified medium as a scratch medium (without a confirmation prompt). The data on the data medium is overwritten by the next scratch mount command.**

See Table 5-43 for an explanation of the parameters for the `scr_set` command.

**Table 5-43** Parameters for the Scr\_set Command

| Parameter  | Explanation                                                                                                              |
|------------|--------------------------------------------------------------------------------------------------------------------------|
| poolname   | specifies the pool name in the AMU database to which the medium is to be added.                                          |
| media-type | media type, e.g. 3590. Refer to <i>Media Types</i> on page A-7 into the default pool of which the medium is to be added. |
| volser     | volser specifying the medium which is to become a scratch medium                                                         |



**This command will be rejected with the message EOTHERPOOL if the medium already exists in another scratch pool.**

This will be created in the AMU database if the specified pool name does not exist. The default scratch pool name will be used, e.g. DEFAULTV1, if no scratch pool name is specified. Refer to Figure 5-71 on page 5-49 for an example of the `scr_set` command.

```
dasadmin scr_set -t 3590 000815
```

**Figure 5-71** Example of the Scr\_set Command

## Remove Medium from Scratch Pool (scr\_unset)

The **scr\_unset** command sets the medium specified by the volser to *unscratch* in the AMU database and removes the volser from the scratch pool.

```
dasadmin scr_unset [poolname] [-t media-type]
volser
```

**Figure 5-72** Syntax of a Generic Scr\_unset Command

DAS automatically uses the default pool for the media type specified if the pool name is not specified. A scratch pool will be deleted when the last volser has been removed from the scratch pool. See Table 5-44 for an explanation of the parameters for the **scr\_unset** command.

**Table 5-44** Parameters for the Scr\_unset Command

| Parameter  | Explanation                                                                                 |
|------------|---------------------------------------------------------------------------------------------|
| poolname   | specifies the pool name in the AMU database from which the medium is to be removed          |
| media-type | media type, e.g. 3590. Refer to <i>Media Types</i> on page A-7 to which the volser belongs. |
| volser     | volser specifying the medium which is no longer scratch                                     |

---

---

## Display Client Parameters (show)

The **show** command displays either the access privileges of a client or its operating parameters. See Figure 5-73.

```
dasadmin show [-op] | [-ac] client
```

**Figure 5-73** Syntax of a Generic Show Command

See Table 5-45 for an explanation of the options for the **show** command

**Table 5-45** Options for the Show Command

| Option | Explanation                                                 |
|--------|-------------------------------------------------------------|
| -op    | displays the operating parameters of the client             |
| -ac    | displays the access privileges of the client                |
| client | client for which the current parameters are to be displayed |



**Only one parameter(-op, -ac) may be specified.**

See Figure 5-74 for an example of the **show** command with the -op option.

```
dasadmin show -op AMUCLIENT

client: AMUCLIENT client operational parameters
 avc: TRUE
 complete access: TRUE
 dismount: TRUE
 ip_address: 192.168.1.132
```

**Figure 5-74** Example of the Show Command with the -op Option

Refer to Figure 5-75 on page 5-51 for an example of the **show** command with the -ac Option.

```

dasadmin show -ac AMUCLIENT

access parameters for client: AMUADMIN
volser-ranges: 000001-999999
 GR0000-GR9999
drive-range: dlt01,vhs01

```

**Figure 5-75** Example of the Show Command with the -ac Option

**Table 5-46** Parameters for the Show Command

| Parameter       | Explanation                                                                                                         |
|-----------------|---------------------------------------------------------------------------------------------------------------------|
| avc             | (true or false) avoid volume contention parameter; determines the reaction to a medium already located in the drive |
| complete access | (true or false) parameter requests for complete or restricted access                                                |
| dismount        | (true or false) parameter for controlling an automatic dismount at the next mount                                   |
| ip_address      | IP address belonging to the client (if no address verification: 0.0.0.0)                                            |
| volser-range    | ranges of volsers that the clients is to be permitted to access                                                     |
| drive-range     | drives the client is to be permitted to access                                                                      |

---

---

## Shut Down DAS (shutdown)

The **shutdown** command shuts down DAS operations, but not the AMS or the OS/2 operating system. See Figure 5-76.

```
dasadmin shutdown [now]
dasadmin shut [now]
```

**Figure 5-76** Syntax of a Generic Shutdown Command

See Table 5-47 for an explanation of the parameter for the **shutdown** command.

**Table 5-47** Parameter for the Shutdown Command

| Parameter | Explanation                                                                                                                                                        |
|-----------|--------------------------------------------------------------------------------------------------------------------------------------------------------------------|
| now       | DAS will be shut down regardless of any outstanding commands. All commands still waiting in the DAS command queue will be processed if the option is not specified |

### **Caution**

**Your applications will no longer be able to access the AML system after shut-down. Make sure that your application does not need additional media from the AML system.**

Also refer to *Shut Down the AMU PC (killamu)* on page 5-24

## Switch to the Passive AMU (switch)

The **switch** command switches the passive AMU to the active AMU and, if possible, the active AMU to passive AMU where dual AMU with dual DAS is in use. Any automatic switching device being used to control the robotic controller will also be switched. See Figure 5-77.

```
dasadmin switch -n | -f
```

**Figure 5-77** Syntax of a Generic Switch Command

Refer to Table 5-48 on page 5-53 for an explanation of the parameters for the **switch** command.



**Table 5-48** Parameters for the Switch Command

| Parameter | Explanation                                                                                                                                                                                                                |
|-----------|----------------------------------------------------------------------------------------------------------------------------------------------------------------------------------------------------------------------------|
| -n        | normal switching procedure with termination of all commands still running on the AMU. This option is only possible if the currently active AMU is still operational.                                                       |
| -f        | immediate switching ( <b>force</b> ) regardless of commands still running or a database that may not yet be synchronized. (Changes to the databank for the last command may not yet have been transmitted to the dual AMU) |



**Caution**

Only use the -f option if the -n option is no longer functioning. There is a risk that anomalies in the AMU database may be caused.

## Operate Drive Buttons (unload)

The **unload** command causes the robotic controller to operate one or two buttons on the drive. Which buttons and how many buttons are operated is determined by the robotic controller configuration in the AML. See Figure 5-78.

```
dasadmin unload drive
```

**Figure 5-78** Syntax of a Generic Unload Command

See Table 5-49 for an explanation of the parameter for the **unload** command.

**Table 5-49** Parameter for the Unload Command

| Parameter | Explanation                                                        |
|-----------|--------------------------------------------------------------------|
| drive     | name of the drive (AMS description) for the <b>unload</b> command. |

Refer to Figure 5-79 on page 5-54 for an example of the **unload** command.

```
dasadmin unload odisk01
```

**Figure 5-79** Example of the Unload Command

## Obtain Information on a Volser (view)

The **view** command displays current information for one volser from the AMU database. See Figure 5-80.

```
dasadmin view [-t media-type] volser
```

**Figure 5-80** Syntax of a Generic View Command

See Table 5-50 for an explanation of the parameters for the **view** command.

**Table 5-50** Parameters for the View Command

| Parameter  | Explanation                                                                                 |
|------------|---------------------------------------------------------------------------------------------|
| media-type | media type, e.g. 3590. Refer to <i>Media Types</i> on page A-7 to which the volser belongs. |
| volser     | volser specifying the medium for which information is being queried.                        |

See Figure 5-81 for an example of the returned status.

```
dasadmin view 000026

volser = 000026
type = A attrib = M
coordinate = L8010103
Use Count = 8740
Crash Count = 0
```

**Figure 5-81** Example of Return Status

Refer to Table 5-51 on page 5-55 for an explanation of the Returned Status.

**Table 5-51** Explanation of Return Status

| <b>Displa</b> | <b>Explanation</b>                                                                          |                                                                                                                             |
|---------------|---------------------------------------------------------------------------------------------|-----------------------------------------------------------------------------------------------------------------------------|
| volser        | queried volser (search criterion in the AMU database)                                       |                                                                                                                             |
| type          | type of slot (coordinate in the archive)                                                    |                                                                                                                             |
|               | A                                                                                           | AMU Dynamic (dynamic storage locations in the AML system)                                                                   |
|               | S                                                                                           | storage (dynamic storage locations in the AML system)                                                                       |
|               | N                                                                                           | clean (cleaning media storage locations)                                                                                    |
| attrib        | current status of the slot (attributes)                                                     |                                                                                                                             |
|               | O                                                                                           | occupied (slot occupied, medium is in its home position)                                                                    |
|               | E                                                                                           | ejected (slot empty, medium has been placed in the I/O unit)                                                                |
|               | M                                                                                           | mounted (slot empty, medium has been placed in a drive)                                                                     |
|               | I                                                                                           | initial (attribute not used)                                                                                                |
|               | J                                                                                           | in jukebox (slot empty, optical disk has been placed in the jukebox)                                                        |
|               | R                                                                                           | reverse side mounted (slot empty, optical disk has been placed in a drive)                                                  |
|               | Y                                                                                           | empty (slot empty, no medium defined for the slot)                                                                          |
|               | U                                                                                           | undefined (special attribute, used by HCC/MVS)                                                                              |
|               | T                                                                                           | temp here (slot occupied, medium in the problem box)                                                                        |
|               | A                                                                                           | temp away (medium temporarily not at the specified coordinates, in transit on AML/2 with double robotic controller systems) |
| coordinate    | 10-digit logical coordinate specifying the slot (Refer to the <i>AMU Reference Manual</i> ) |                                                                                                                             |

---

---

**Table 5-51** Explanation of Return Status

| <b>Displa</b> | <b>Explanation</b>                                                    |
|---------------|-----------------------------------------------------------------------|
| Use Count     | number of accesses to the slot (not volser) by the robotic controller |
| Crash Count   | not used                                                              |

# 6

## DAS Messages

|                                      |      |
|--------------------------------------|------|
| Overview .....                       | 6-17 |
| DAS Message Classification .....     | 6-17 |
| DAS ACI Messages .....               | 6-17 |
| DAS Server Messages to the ACI ..... | 6-17 |
| Conventions in the Messages .....    | 6-18 |
| DAS Server Messages .....            | 6-18 |
| DAS0001 .....                        | 6-18 |
| DAS ACI Message .....                | 6-18 |
| Explanation .....                    | 6-18 |
| User Activities .....                | 6-18 |
| DAS0002 .....                        | 6-19 |
| DAS ACI Message .....                | 6-19 |
| Explanation .....                    | 6-19 |
| User Activities .....                | 6-19 |
| DAS0003 .....                        | 6-19 |
| DAS ACI Message .....                | 6-19 |
| Explanation .....                    | 6-19 |
| User Activities .....                | 6-19 |
| DAS3000 .....                        | 6-20 |
| DAS ACI Message .....                | 6-20 |
| Explanation .....                    | 6-20 |
| User Activities .....                | 6-20 |
| DAS3001 .....                        | 6-20 |
| DAS ACI Message .....                | 6-20 |
| Explanation .....                    | 6-20 |
| User Activities .....                | 6-20 |
| DAS3002 .....                        | 6-21 |
| DAS ACI Message .....                | 6-21 |
| Explanation .....                    | 6-21 |
| User Activities .....                | 6-21 |
| DAS3003 .....                        | 6-21 |
| DAS ACI Message .....                | 6-21 |



---



---

|                       |      |
|-----------------------|------|
| Explanation .....     | 6-21 |
| User Activities ..... | 6-21 |
| DAS3004 .....         | 6-22 |
| DAS ACI Message ..... | 6-22 |
| Explanation .....     | 6-22 |
| User Activities ..... | 6-22 |
| DAS3020 .....         | 6-22 |
| DAS ACI Message ..... | 6-22 |
| Explanation .....     | 6-22 |
| User Activities ..... | 6-22 |
| DAS 3021 .....        | 6-23 |
| DAS ACI Message ..... | 6-23 |
| Explanation .....     | 6-23 |
| User Activities ..... | 6-23 |
| DAS3022 .....         | 6-23 |
| DAS ACI Message ..... | 6-23 |
| Explanation .....     | 6-23 |
| User Activities ..... | 6-23 |
| DAS3023 .....         | 6-24 |
| DAS ACI Message ..... | 6-24 |
| Explanation .....     | 6-24 |
| User Activities ..... | 6-24 |
| DAS3500 .....         | 6-24 |
| DAS ACI Message ..... | 6-24 |
| Explanation .....     | 6-24 |
| User Activities ..... | 6-25 |
| DAS3501 .....         | 6-25 |
| DAS ACI Message ..... | 6-25 |
| Explanation .....     | 6-25 |
| User Activities ..... | 6-25 |
| DAS3502 .....         | 6-25 |
| DAS ACI Message ..... | 6-25 |
| Explanation .....     | 6-25 |
| User Activities ..... | 6-26 |
| DAS3503 .....         | 6-26 |
| DAS ACI Message ..... | 6-26 |
| Explanation .....     | 6-26 |
| User Activities ..... | 6-26 |
| DAS3504 .....         | 6-26 |
| DAS ACI Message ..... | 6-26 |
| Explanation .....     | 6-26 |
| User Activities ..... | 6-27 |
| DAS4000 .....         | 6-27 |
| DAS ACI Message ..... | 6-27 |
| Explanation .....     | 6-27 |
| User Activities ..... | 6-27 |
| DAS4001 .....         | 6-27 |
| DAS ACI Message ..... | 6-27 |
| Explanation .....     | 6-28 |

---



---

|                       |      |
|-----------------------|------|
| User Activities ..... | 6-28 |
| DAS4002 .....         | 6-28 |
| DAS ACI Message ..... | 6-28 |
| Explanation .....     | 6-28 |
| User Activities ..... | 6-28 |
| DAS4003 .....         | 6-29 |
| DAS ACI Message ..... | 6-29 |
| Explanation .....     | 6-29 |
| User Activities ..... | 6-29 |
| DAS4004 .....         | 6-29 |
| DAS ACI Message ..... | 6-29 |
| Explanation .....     | 6-29 |
| User Activities ..... | 6-30 |
| DAS4005 .....         | 6-30 |
| DAS ACI Message ..... | 6-30 |
| Explanation .....     | 6-30 |
| User Activities ..... | 6-30 |
| DAS4006 .....         | 6-31 |
| DAS ACI Message ..... | 6-31 |
| Explanation .....     | 6-31 |
| User Activities ..... | 6-31 |
| DAS4007 .....         | 6-31 |
| DAS ACI Message ..... | 6-31 |
| Explanation .....     | 6-31 |
| User Activities ..... | 6-32 |
| DAS4010 .....         | 6-32 |
| DAS ACI Message ..... | 6-32 |
| Explanation .....     | 6-32 |
| User Activities ..... | 6-32 |
| DAS4011 .....         | 6-33 |
| DAS ACI Message ..... | 6-33 |
| Explanation .....     | 6-33 |
| User Activities ..... | 6-33 |
| DAS4012 .....         | 6-33 |
| DAS ACI Message ..... | 6-33 |
| Explanation .....     | 6-33 |
| User Activities ..... | 6-34 |
| DAS4013 .....         | 6-34 |
| DAS ACI Message ..... | 6-34 |
| Explanation .....     | 6-34 |
| User Activities ..... | 6-34 |
| DAS4020 .....         | 6-35 |
| DAS ACI Message ..... | 6-35 |
| Explanation .....     | 6-35 |
| User Activities ..... | 6-35 |
| DAS4021 .....         | 6-35 |
| DAS ACI Message ..... | 6-35 |
| Explanation .....     | 6-35 |
| User Activities ..... | 6-35 |

---



---

|                 |      |
|-----------------|------|
| DAS4022         | 6-36 |
| DAS ACI Message | 6-36 |
| Explanation     | 6-36 |
| User Activities | 6-36 |
| DAS4023         | 6-36 |
| DAS ACI Message | 6-36 |
| Explanation     | 6-36 |
| User Activities | 6-36 |
| DAS4024         | 6-37 |
| DAS ACI Message | 6-37 |
| Explanation     | 6-37 |
| User Activities | 6-37 |
| DAS4030         | 6-38 |
| DAS ACI Message | 6-38 |
| Explanation     | 6-38 |
| User Activities | 6-38 |
| DAS4031         | 6-38 |
| DAS ACI Message | 6-38 |
| Explanation     | 6-38 |
| User Activities | 6-38 |
| DAS4032         | 6-39 |
| DAS ACI Message | 6-39 |
| Explanation     | 6-39 |
| User Activities | 6-39 |
| DAS4033         | 6-39 |
| DAS ACI Message | 6-39 |
| Explanation     | 6-39 |
| User Activities | 6-40 |
| DAS4040         | 6-40 |
| DAS ACI Message | 6-40 |
| Explanation     | 6-40 |
| User Activities | 6-40 |
| DAS4041         | 6-40 |
| DAS ACI Message | 6-40 |
| Explanation     | 6-41 |
| User Activities | 6-41 |
| DAS4042         | 6-41 |
| DAS ACI Message | 6-41 |
| Explanation     | 6-41 |
| User Activities | 6-41 |
| DAS4043         | 6-42 |
| DAS ACI Message | 6-42 |
| Explanation     | 6-42 |
| User Activities | 6-42 |
| DAS4044         | 6-42 |
| DAS ACI Message | 6-42 |
| Explanation     | 6-42 |
| User Activities | 6-43 |
| DAS4045         | 6-43 |



---



---

|                       |      |
|-----------------------|------|
| DAS ACI Message ..... | 6-43 |
| Explanation .....     | 6-43 |
| User Activities ..... | 6-43 |
| DAS4050 .....         | 6-44 |
| DAS ACI Message ..... | 6-44 |
| Explanation .....     | 6-44 |
| User Activities ..... | 6-44 |
| DAS4051 .....         | 6-44 |
| DAS ACI Message ..... | 6-44 |
| Explanation .....     | 6-44 |
| User Activities ..... | 6-44 |
| DAS4052 .....         | 6-45 |
| DAS ACI Message ..... | 6-45 |
| Explanation .....     | 6-45 |
| User Activities ..... | 6-45 |
| DAS4053 .....         | 6-45 |
| DAS ACI Message ..... | 6-45 |
| Explanation .....     | 6-45 |
| User Activities ..... | 6-45 |
| DAS4054 .....         | 6-46 |
| DAS ACI Message ..... | 6-46 |
| Explanation .....     | 6-46 |
| User Activities ..... | 6-46 |
| DAS4055 .....         | 6-46 |
| DAS ACI Message ..... | 6-46 |
| Explanation .....     | 6-47 |
| User Activities ..... | 6-47 |
| DAS4056 .....         | 6-47 |
| DAS ACI Message ..... | 6-47 |
| Explanation .....     | 6-47 |
| User Activities ..... | 6-47 |
| DAS4057 .....         | 6-48 |
| DAS ACI Message ..... | 6-48 |
| Explanation .....     | 6-48 |
| User Activities ..... | 6-48 |
| DAS4060 .....         | 6-48 |
| DAS ACI Message ..... | 6-48 |
| Explanation .....     | 6-48 |
| User Activities ..... | 6-48 |
| DAS4061 .....         | 6-49 |
| DAS ACI Message ..... | 6-49 |
| Explanation .....     | 6-49 |
| User Activities ..... | 6-49 |
| DAS4062 .....         | 6-49 |
| DAS ACI Message ..... | 6-49 |
| Explanation .....     | 6-49 |
| User Activities ..... | 6-49 |
| DAS4063 .....         | 6-50 |
| DAS ACI Message ..... | 6-50 |

---



---

|                       |      |
|-----------------------|------|
| Explanation .....     | 6-50 |
| User Activities ..... | 6-50 |
| DAS4064 .....         | 6-50 |
| DAS ACI Message ..... | 6-50 |
| Explanation .....     | 6-50 |
| User Activities ..... | 6-51 |
| DAS4065 .....         | 6-51 |
| DAS ACI Message ..... | 6-51 |
| Explanation .....     | 6-51 |
| User Activities ..... | 6-51 |
| DAS4066 .....         | 6-51 |
| DAS ACI Message ..... | 6-51 |
| Explanation .....     | 6-51 |
| User Activities ..... | 6-52 |
| DAS4070 .....         | 6-52 |
| DAS ACI Message ..... | 6-52 |
| Explanation .....     | 6-52 |
| User Activities ..... | 6-52 |
| DAS4071 .....         | 6-52 |
| DAS ACI Message ..... | 6-52 |
| Explanation .....     | 6-53 |
| User Activities ..... | 6-53 |
| DAS4072 .....         | 6-53 |
| DAS ACI Message ..... | 6-53 |
| Explanation .....     | 6-53 |
| User Activities ..... | 6-53 |
| DAS4080 .....         | 6-53 |
| DAS ACI Message ..... | 6-53 |
| Explanation .....     | 6-54 |
| User Activities ..... | 6-54 |
| DAS4081 .....         | 6-54 |
| DAS ACI Message ..... | 6-54 |
| Explanation .....     | 6-54 |
| User Activities ..... | 6-54 |
| DAS4082 .....         | 6-54 |
| DAS ACI Message ..... | 6-54 |
| Explanation .....     | 6-54 |
| User Activities ..... | 6-55 |
| DAS4090 .....         | 6-55 |
| DAS ACI Message ..... | 6-55 |
| Explanation .....     | 6-55 |
| User Activities ..... | 6-55 |
| DAS4091 .....         | 6-55 |
| DAS ACI Message ..... | 6-55 |
| Explanation .....     | 6-55 |
| User Activities ..... | 6-56 |
| DAS4092 .....         | 6-56 |
| DAS ACI Message ..... | 6-56 |
| Explanation .....     | 6-56 |

---



---

|                       |      |
|-----------------------|------|
| User Activities ..... | 6-56 |
| DAS4093 .....         | 6-56 |
| DAS ACI Message ..... | 6-56 |
| Explanation .....     | 6-57 |
| User Activities ..... | 6-57 |
| DAS4094 .....         | 6-57 |
| DAS ACI Message ..... | 6-57 |
| Explanation .....     | 6-57 |
| User Activities ..... | 6-57 |
| DAS4095 .....         | 6-58 |
| DAS ACI Message ..... | 6-58 |
| Explanation .....     | 6-58 |
| User Activities ..... | 6-58 |
| DAS4096 .....         | 6-58 |
| DAS ACI Message ..... | 6-58 |
| Explanation .....     | 6-59 |
| User Activities ..... | 6-59 |
| DAS4100 .....         | 6-59 |
| DAS ACI Message ..... | 6-59 |
| Explanation .....     | 6-59 |
| User Activities ..... | 6-59 |
| DAS4101 .....         | 6-60 |
| DAS ACI Message ..... | 6-60 |
| Explanation .....     | 6-60 |
| User Activities ..... | 6-60 |
| DAS4102 .....         | 6-60 |
| DAS ACI Message ..... | 6-60 |
| Explanation .....     | 6-60 |
| User Activities ..... | 6-60 |
| DAS4110 .....         | 6-61 |
| DAS ACI Message ..... | 6-61 |
| Explanation .....     | 6-61 |
| User Activities ..... | 6-61 |
| DAS4111 .....         | 6-61 |
| DAS ACI Message ..... | 6-61 |
| Explanation .....     | 6-61 |
| User Activities ..... | 6-61 |
| DAS4120 .....         | 6-62 |
| DAS ACI Message ..... | 6-62 |
| Explanation .....     | 6-62 |
| User Activities ..... | 6-62 |
| DAS4121 .....         | 6-62 |
| DAS ACI Message ..... | 6-62 |
| Explanation .....     | 6-62 |
| User Activities ..... | 6-62 |
| DAS4130 .....         | 6-63 |
| DAS ACI Message ..... | 6-63 |
| Explanation .....     | 6-63 |
| User Activities ..... | 6-63 |

---



---

|                 |      |
|-----------------|------|
| DAS4131         | 6-63 |
| DAS ACI Message | 6-63 |
| Explanation     | 6-63 |
| User Activities | 6-63 |
| DAS4140         | 6-64 |
| DAS ACI Message | 6-64 |
| Explanation     | 6-64 |
| User Activities | 6-64 |
| DAS4141         | 6-64 |
| DAS ACI Message | 6-64 |
| Explanation     | 6-64 |
| User Activities | 6-64 |
| DAS4150         | 6-65 |
| DAS ACI Message | 6-65 |
| Explanation     | 6-65 |
| User Activities | 6-65 |
| DAS4151         | 6-65 |
| DAS ACI Message | 6-65 |
| Explanation     | 6-65 |
| User Activities | 6-65 |
| DAS4160         | 6-66 |
| DAS ACI Message | 6-66 |
| Explanation     | 6-66 |
| User Activities | 6-66 |
| DAS4161         | 6-66 |
| DAS ACI Message | 6-66 |
| Explanation     | 6-66 |
| User Activities | 6-66 |
| DAS4170         | 6-67 |
| DAS ACI Message | 6-67 |
| Explanation     | 6-67 |
| User Activities | 6-67 |
| DAS4171         | 6-67 |
| DAS ACI Message | 6-67 |
| Explanation     | 6-67 |
| User Activities | 6-67 |
| DAS4180         | 6-68 |
| DAS ACI Message | 6-68 |
| Explanation     | 6-68 |
| User Activities | 6-68 |
| DAS4181         | 6-68 |
| DAS ACI Message | 6-68 |
| Explanation     | 6-68 |
| User Activities | 6-68 |
| DAS4190         | 6-69 |
| DAS ACI Message | 6-69 |
| Explanation     | 6-69 |
| User Activities | 6-69 |
| DAS4191         | 6-69 |

---



---

|                       |      |
|-----------------------|------|
| DAS ACI Message ..... | 6-69 |
| Explanation .....     | 6-69 |
| User Activities ..... | 6-69 |
| DAS4200 .....         | 6-70 |
| DAS ACI Message ..... | 6-70 |
| Explanation .....     | 6-70 |
| User Activities ..... | 6-70 |
| DAS4201 .....         | 6-70 |
| DAS ACI Message ..... | 6-70 |
| Explanation .....     | 6-70 |
| User Activities ..... | 6-70 |
| DAS4204 .....         | 6-71 |
| DAS ACI Message ..... | 6-71 |
| Explanation .....     | 6-71 |
| User Activities ..... | 6-71 |
| DAS4205 .....         | 6-71 |
| DAS ACI Message ..... | 6-71 |
| Explanation .....     | 6-71 |
| User Activities ..... | 6-71 |
| DAS4210 .....         | 6-72 |
| DAS ACI Message ..... | 6-72 |
| Explanation .....     | 6-72 |
| User Activities ..... | 6-72 |
| DAS4211 .....         | 6-72 |
| DAS ACI Message ..... | 6-72 |
| Explanation .....     | 6-72 |
| User Activities ..... | 6-72 |
| DAS4220 .....         | 6-73 |
| DAS ACI Message ..... | 6-73 |
| Explanation .....     | 6-73 |
| User Activities ..... | 6-73 |
| DAS4221 .....         | 6-74 |
| DAS ACI Message ..... | 6-74 |
| Explanation .....     | 6-74 |
| User Activities ..... | 6-74 |
| DAS4230 .....         | 6-74 |
| DAS ACI Message ..... | 6-74 |
| Explanation .....     | 6-74 |
| User Activities ..... | 6-74 |
| DAS4231 .....         | 6-75 |
| DAS ACI Message ..... | 6-75 |
| Explanation .....     | 6-75 |
| User Activities ..... | 6-75 |
| DAS4232 .....         | 6-75 |
| DAS ACI Message ..... | 6-75 |
| Explanation .....     | 6-75 |
| User Activities ..... | 6-75 |
| DAS4240 .....         | 6-76 |
| DAS ACI Message ..... | 6-76 |

---



---

|                       |      |
|-----------------------|------|
| Explanation .....     | 6-76 |
| User Activities ..... | 6-76 |
| DAS4241 .....         | 6-76 |
| DAS ACI Message ..... | 6-76 |
| Explanation .....     | 6-76 |
| User Activities ..... | 6-77 |
| DAS4242 .....         | 6-77 |
| DAS ACI Message ..... | 6-77 |
| Explanation .....     | 6-77 |
| User Activities ..... | 6-77 |
| DAS4250 .....         | 6-77 |
| DAS ACI Message ..... | 6-77 |
| Explanation .....     | 6-77 |
| User Activities ..... | 6-78 |
| DAS4251 .....         | 6-78 |
| DAS ACI Message ..... | 6-78 |
| Explanation .....     | 6-78 |
| User Activities ..... | 6-78 |
| DAS4260 .....         | 6-78 |
| DAS ACI Message ..... | 6-78 |
| Explanation .....     | 6-78 |
| User Activities ..... | 6-78 |
| DAS4261 .....         | 6-79 |
| DAS ACI Message ..... | 6-79 |
| Explanation .....     | 6-79 |
| User Activities ..... | 6-79 |
| DAS4270 .....         | 6-79 |
| DAS ACI Message ..... | 6-79 |
| Explanation .....     | 6-79 |
| User Activities ..... | 6-79 |
| DAS4271 .....         | 6-80 |
| DAS ACI Message ..... | 6-80 |
| Explanation .....     | 6-80 |
| User Activities ..... | 6-80 |
| DAS4272 .....         | 6-80 |
| DAS ACI Message ..... | 6-80 |
| Explanation .....     | 6-80 |
| User Activities ..... | 6-80 |
| DAS4280 .....         | 6-81 |
| DAS ACI Message ..... | 6-81 |
| Explanation .....     | 6-81 |
| User Activities ..... | 6-81 |
| DAS4281 .....         | 6-81 |
| DAS ACI Message ..... | 6-81 |
| Explanation .....     | 6-81 |
| User Activities ..... | 6-81 |
| DAS4282 .....         | 6-82 |
| DAS ACI Message ..... | 6-82 |
| Explanation .....     | 6-82 |

---



---

|                       |      |
|-----------------------|------|
| User Activities ..... | 6-82 |
| DAS4290 .....         | 6-82 |
| DAS ACI Message ..... | 6-82 |
| Explanation .....     | 6-82 |
| User Activities ..... | 6-83 |
| DAS4291 .....         | 6-83 |
| DAS ACI Message ..... | 6-83 |
| Explanation .....     | 6-83 |
| User Activities ..... | 6-83 |
| DAS4292 .....         | 6-83 |
| DAS ACI Message ..... | 6-83 |
| Explanation .....     | 6-83 |
| User Activities ..... | 6-83 |
| DAS4293 .....         | 6-84 |
| DAS ACI Message ..... | 6-84 |
| Explanation .....     | 6-84 |
| User Activities ..... | 6-84 |
| DAS4295 .....         | 6-84 |
| DAS ACI Message ..... | 6-84 |
| Explanation .....     | 6-84 |
| User Activities ..... | 6-85 |
| DAS4296 .....         | 6-86 |
| DAS ACI Message ..... | 6-86 |
| Explanation .....     | 6-86 |
| User Activities ..... | 6-86 |
| DAS4297 .....         | 6-86 |
| DAS ACI Message ..... | 6-86 |
| Explanation .....     | 6-86 |
| User Activities ..... | 6-87 |
| DAS4300 .....         | 6-87 |
| Explanation .....     | 6-87 |
| User Activities ..... | 6-87 |
| DAS4301 .....         | 6-87 |
| DAS ACI Message ..... | 6-87 |
| Explanation .....     | 6-87 |
| User Activities ..... | 6-88 |
| DAS4302 .....         | 6-88 |
| DAS ACI Message ..... | 6-88 |
| Explanation .....     | 6-88 |
| User Activities ..... | 6-88 |
| DAS4400 .....         | 6-88 |
| Explanation .....     | 6-88 |
| User Activities ..... | 6-88 |
| DAS4401 .....         | 6-89 |
| DAS ACI Message ..... | 6-89 |
| Explanation .....     | 6-89 |
| User Activities ..... | 6-89 |
| DAS4402 .....         | 6-89 |
| DAS ACI Message ..... | 6-89 |

---



---

|                        |      |
|------------------------|------|
| Explanation .....      | 6-89 |
| User Activities .....  | 6-89 |
| DAS ACI Messages ..... | 6-90 |
| ACI0001 .....          | 6-90 |
| Explanation .....      | 6-90 |
| User Activities .....  | 6-90 |
| ACI0002 .....          | 6-90 |
| Explanation .....      | 6-90 |
| User Activities .....  | 6-90 |
| ACI0003 .....          | 6-91 |
| Explanation .....      | 6-91 |
| User Activities .....  | 6-91 |
| ACI0004 .....          | 6-91 |
| Explanation .....      | 6-91 |
| User Activities .....  | 6-91 |
| ACI0005 .....          | 6-92 |
| Explanation .....      | 6-92 |
| User Activities .....  | 6-92 |
| ACI0006 .....          | 6-92 |
| Explanation .....      | 6-92 |
| User Activities .....  | 6-92 |
| ACI0007 .....          | 6-93 |
| Explanation .....      | 6-93 |
| User Activities .....  | 6-93 |
| ACI0008 .....          | 6-93 |
| Explanation .....      | 6-93 |
| User Activities .....  | 6-93 |
| ACI0009 .....          | 6-93 |
| Explanation .....      | 6-93 |
| User Activities .....  | 6-93 |
| ACI0010 .....          | 6-94 |
| Explanation .....      | 6-94 |
| User Activities .....  | 6-94 |
| ACI0011 .....          | 6-94 |
| Explanation .....      | 6-94 |
| User Activities .....  | 6-94 |
| ACI0012 .....          | 6-94 |
| Explanation .....      | 6-94 |
| User Activities .....  | 6-94 |
| ACI0013 .....          | 6-95 |
| Explanation .....      | 6-95 |
| User Activities .....  | 6-95 |
| ACI0014 .....          | 6-95 |
| Explanation .....      | 6-95 |
| User Activities .....  | 6-95 |
| ACI0015 .....          | 6-95 |
| Explanation .....      | 6-95 |
| User Activities .....  | 6-95 |
| ACI0020 .....          | 6-96 |



---



---

|                        |       |
|------------------------|-------|
| Explanation .....      | 6-96  |
| User Activities .....  | 6-96  |
| ACI0021 .....          | 6-96  |
| Explanation .....      | 6-96  |
| User Activities .....  | 6-96  |
| ACI0022 .....          | 6-97  |
| Explanation .....      | 6-97  |
| User Activities .....  | 6-97  |
| ACI0023 .....          | 6-97  |
| Explanation .....      | 6-97  |
| User Activities .....  | 6-97  |
| ACI0024 .....          | 6-98  |
| Explanation .....      | 6-98  |
| User Activities .....  | 6-98  |
| Derrno Variable .....  | 6-99  |
| 0 - EOK .....          | 6-99  |
| Explanation .....      | 6-99  |
| User Activities .....  | 6-99  |
| 1 - ERPC .....         | 6-99  |
| Explanation .....      | 6-99  |
| User Activities .....  | 6-99  |
| 2 - EINVAL .....       | 6-100 |
| Explanation .....      | 6-100 |
| User Activities .....  | 6-100 |
| 3 - ENOVOLUME .....    | 6-100 |
| Explanation .....      | 6-100 |
| User Activities .....  | 6-100 |
| 4 - ENODRIVE .....     | 6-101 |
| Explanation .....      | 6-101 |
| User Activities .....  | 6-101 |
| 5 - EDRVOCCUPIED ..... | 6-101 |
| Explanation .....      | 6-101 |
| User Activities .....  | 6-101 |
| 6 - EPROBVOL .....     | 6-102 |
| Explanation .....      | 6-102 |
| User Activities .....  | 6-102 |
| 7 - EAMU .....         | 6-102 |
| Explanation .....      | 6-102 |
| User Activities .....  | 6-102 |
| 8 - EAMUCOMM .....     | 6-103 |
| Explanation .....      | 6-103 |
| User Activities .....  | 6-103 |
| 9 - EROBOT .....       | 6-103 |
| Explanation .....      | 6-103 |
| User Activities .....  | 6-103 |
| 10 - EROBOTCOMM .....  | 6-104 |
| Explanation .....      | 6-104 |
| User Activities .....  | 6-104 |
| 11 - ENODAS .....      | 6-104 |

---



---

|                        |                       |       |
|------------------------|-----------------------|-------|
|                        | Explanation .....     | 6-104 |
|                        | User Activities ..... | 6-104 |
| 12 - EDEVEMPTY .....   |                       | 6-105 |
|                        | Explanation .....     | 6-105 |
|                        | User Activities ..... | 6-105 |
| 13 - ENOTREG .....     |                       | 6-105 |
|                        | Explanation .....     | 6-105 |
|                        | User Activities ..... | 6-105 |
| 14 - EBADHOST .....    |                       | 6-106 |
|                        | Explanation .....     | 6-106 |
|                        | User Activities ..... | 6-106 |
| 15 - ENOAREA .....     |                       | 6-106 |
|                        | Explanation .....     | 6-106 |
|                        | User Activities ..... | 6-106 |
| 16 - ENOTAUTH .....    |                       | 6-107 |
|                        | Explanation .....     | 6-107 |
|                        | User Activities ..... | 6-107 |
| 17 - EDYNFULL .....    |                       | 6-107 |
|                        | Explanation .....     | 6-107 |
|                        | User Activities ..... | 6-107 |
| 18 - EUPELSE .....     |                       | 6-108 |
|                        | Explanation .....     | 6-108 |
|                        | User Activities ..... | 6-108 |
| 19 - EBADCLIENT .....  |                       | 6-108 |
|                        | Explanation .....     | 6-108 |
|                        | User Activities ..... | 6-108 |
| 20 - EBADDYN .....     |                       | 6-109 |
|                        | Explanation .....     | 6-109 |
|                        | User Activities ..... | 6-109 |
| 21 - ENOREQ .....      |                       | 6-109 |
|                        | Explanation .....     | 6-109 |
|                        | User Activities ..... | 6-109 |
| 22 - ERETRYL .....     |                       | 6-110 |
|                        | Explanation .....     | 6-110 |
|                        | User Activities ..... | 6-110 |
| 23 - ENOTMOUNTED ..... |                       | 6-110 |
|                        | Explanation .....     | 6-110 |
|                        | User Activities ..... | 6-110 |
| 24 - EINUSE .....      |                       | 6-111 |
|                        | Explanation .....     | 6-111 |
|                        | User Activities ..... | 6-111 |
| 25 - ENOSPACE .....    |                       | 6-111 |
|                        | Explanation .....     | 6-111 |
|                        | User Activities ..... | 6-111 |
| 26 - ENOTFOUND .....   |                       | 6-112 |
|                        | Explanation .....     | 6-112 |
|                        | User Activities ..... | 6-112 |
| 27 - ECANCELLED .....  |                       | 6-112 |
|                        | Explanation .....     | 6-112 |

---



---

|                          |                       |       |
|--------------------------|-----------------------|-------|
|                          | User Activities ..... | 6-112 |
| 28 - EDASIN .....        |                       | 6-113 |
|                          | Explanation .....     | 6-113 |
|                          | User Activities ..... | 6-113 |
| 29 - EACIINT .....       |                       | 6-113 |
|                          | Explanation .....     | 6-113 |
|                          | User Activities ..... | 6-113 |
| 30 - EMOREDATA .....     |                       | 6-114 |
|                          | Explanation .....     | 6-114 |
|                          | User Activities ..... | 6-114 |
| 31 - ENOMATCH .....      |                       | 6-114 |
|                          | Explanation .....     | 6-114 |
|                          | User Activities ..... | 6-114 |
| 32 - EOTHERPOOL .....    |                       | 6-115 |
|                          | Explanation .....     | 6-115 |
|                          | User Activities ..... | 6-115 |
| 33 - ECLEANING .....     |                       | 6-115 |
|                          | Explanation .....     | 6-115 |
|                          | User Activities ..... | 6-115 |
| 34 - ETIMEOUT .....      |                       | 6-116 |
|                          | Explanation .....     | 6-116 |
|                          | User Activities ..... | 6-116 |
| 35 - ESWITCHINPROG ..... |                       | 6-116 |
|                          | Explanation .....     | 6-116 |
|                          | User Activities ..... | 6-116 |
| 36 - ENOPOOL .....       |                       | 6-117 |
|                          | Explanation .....     | 6-117 |
|                          | User Activities ..... | 6-117 |
| 37 - EAREAFULL .....     |                       | 6-117 |
|                          | Explanation .....     | 6-117 |
|                          | User Activities ..... | 6-117 |
| 38 - EHICAPINUSE .....   |                       | 6-118 |
|                          | Explanation .....     | 6-118 |
|                          | User Activities ..... | 6-118 |
| 39 - ENODOUBLESIDE ..... |                       | 6-118 |
|                          | Explanation .....     | 6-118 |
|                          | User Activities ..... | 6-118 |
| 40- EEXUP .....          |                       | 6-118 |
|                          | Explanation .....     | 6-118 |
|                          | User Activities ..... | 6-118 |
| 41- EPROBDEV .....       |                       | 6-119 |
|                          | Explanation .....     | 6-119 |
|                          | User Activities ..... | 6-119 |
| 42- ECOORDINATE .....    |                       | 6-119 |
|                          | Explanation .....     | 6-119 |
|                          | User Activities ..... | 6-119 |
| 43- EAREAEMPTY .....     |                       | 6-119 |
|                          | User Activities ..... | 6-119 |
| 44- EBARCODE .....       |                       | 6-119 |

---



---

|                   |                       |       |
|-------------------|-----------------------|-------|
|                   | Explanation .....     | 6-120 |
|                   | User Activities ..... | 6-120 |
| 45 - EUPDOWN      | .....                 | 6-120 |
|                   | Explanation .....     | 6-120 |
|                   | User Activities ..... | 6-120 |
| 46 - ENOTSUPPHCMD | .....                 | 6-120 |
|                   | Explanation .....     | 6-120 |
|                   | User Activities ..... | 6-120 |
| 47 - EDATABASE    | .....                 | 6-120 |
|                   | Explanation .....     | 6-120 |
|                   | User Activities ..... | 6-121 |
| 48 - ENOROBOT     | .....                 | 6-121 |
|                   | Explanation .....     | 6-121 |
|                   | User Activities ..... | 6-121 |
| 49 - EINVALIDDEV  | .....                 | 6-121 |
|                   | Explanation .....     | 6-121 |
|                   | User Activities ..... | 6-121 |
| 50 - NO_ECODES    | .....                 | 6-121 |
|                   | Explanation .....     | 6-121 |
|                   | User Activities ..... | 6-121 |

---

---

## ■ Overview

Messages from DAS are used to provide information regarding activities and faults in the server process on the AMU.

## ■ DAS Message Classification

All DAS messages are recorded in the AMU log. The messages are displayed

- in the AMS log window server
- in the AMU remote log program using telnet
- in the calling client process (error messages only)

DAS messages may be classified as:

- DAS information
- DAS software error messages
- DAS drive cleaning messages
- Client requests
  - Start of the request
  - Completion of the request
  - Error in processing the request

## ■ DAS ACI Messages

DAS ACI messages are error messages generated by the ACI software on the relevant client. No communication with the AMU has taken place in these cases. The error message is written to the client's default output device (console).

## ■ DAS Server Messages to the ACI

In the event of errors in command processing on the (DAS or AMS), the command is acknowledged to the ACI with a DAS error number (*d\_errno*). The error name can also be linked using the *derrno.h* file.

---

---

## Conventions in the Messages

- The explanatory text indicates possible causes and the reaction of the system.
- User Activities are instructions on how to rectify the error.

## DAS Server Messages

The following messages originate from the DAS server and are only displayed there.

### DAS0001

*DAS/2 Version %1 is starting...*

param %1    Version number of the DAS software

### DAS ACI Message

EOK

### Explanation

DAS has started and has begun to read the configuration data. In this situation the server is not yet able to correctly process any requests from clients. Initialization is completed, after about a minute, and is indicated by the message *DAS0002* (DAS/2 ready.)

### User Activities

If the message *DAS0002* (DAS/2 ready) does not arrive after this message it means that the system was not able to start DAS successfully.

- Check the log for further DAS error messages
- Check whether TCP/IP has been correctly configured on the portmapper.
- Check whether the AMS is active.
- Check, in the DAS/2 window, whether errors have occurred reading the *config* file.
- Terminate the DAS/2 program by pressing <CTRL>+<-C>
- Check the DAS start behavior by starting it in an OS/2 window in the directory  
c:\DAS issuing the command bin\das2.

- 
- 
- Contact the ADIC/GRAU Storage Systems Customer Help Desk should the error continue to occur.

## **DAS0002**

*DAS/2 ready.*

### **DAS ACI Message**

EOK

### **Explanation**

DAS has successfully completed the initialization phase and is now ready to process commands.

### **User Activities**

No activities required.

## **DAS0003**

*DAS/2 ended.*

### **DAS ACI Message**

EOK

### **Explanation**

The DAS program has ended

### **User Activities**

Start DAS again, if required. (**dasstart**)

---

---

## DAS3000

*Internal DAS error in %1.*

param %1    Name of the module reporting the error

### DAS ACI Message

EDASINT

### Explanation

A situation has occurred during command processing which cannot be rectified by the program.

### User Activities

- Save the associated AMS log. Terminate DAS using <Ctrl>+<c> then restart DAS.
- Contact the ADIC/GRAU Storage Systems Customer Help Desk.

## DAS3001

*Open failed for file %1*

param %1    file which caused the error.

### DAS ACI Message

EDASINT

### Explanation

DAS/2 cannot access a temporary file to terminate the current function.

### User Activities

- Save the associated AMS log. Terminate DAS using <Ctrl>+<c> then restart DAS.
- Contact the ADIC/GRAU Storage Systems Customer Help Desk.



---

---

## DAS3002

*Read failed for %1.*

param %1     File causing the error

### DAS ACI Message

EDASINT

### Explanation

DAS/2 cannot access a temporary file to load the necessary data and terminate the current function.

### User Activities

- Save the associated AMS log. Terminate DAS using <Ctrl>+<c> and then restart DAS.
- Contact the ADIC/GRAU Storage Systems Customer Help Desk.

## DAS3003

*Write failed for file %1.*

param %1     File causing the error

### DAS ACI Message

EDASINT

### Explanation

DAS/2 cannot access a temporary file to save the necessary data and terminate the current function.

### User Activities

- Save the associated AMS log. Terminate DAS using <Ctrl>+<c> then restart DAS.
- Contact the ADIC/GRAU Storage Systems Customer Help Desk.

---

---

## **DAS3004**

*Close failed for file %1.*

param %1     File causing the error

### **DAS ACI Message**

EDASINT

### **Explanation**

DAS/2 cannot access a temporary file to close the file and terminate the function.

### **User Activities**

- Save the associated AMS log. Terminate DAS using <Ctrl>+<c> then restart DAS.
- Contact the ADIC/GRAU Storage Systems Customer Help Desk.

## **DAS3020**

*Internal request list problem.*

### **DAS ACI Message**

EDASINT

### **Explanation**

DAS/2 cannot process the internal list of requests due to an error and therefore cannot continue command processing.

### **User Activities**

- Save the associated AMS log. Terminate DAS using <Ctrl>+<c> then restart DAS.
- Contact the ADIC/GRAU Storage Systems Customer Help Desk.

---

---

## DAS 3021

*Cannot send to RQM module.*

### DAS ACI Message

EDASINT

### Explanation

DAS/2 is not able to establish communication with the Request Manager module and therefore cannot process the command.

### User Activities

- Save the associated AMS log. Terminate DAS using <Ctrl>+<c> then restart DAS.
- Contact the ADIC/GRAU Storage Systems Customer Help Desk.

## DAS3022

*Robot not ready for client %1 because Hicap in use.*

param %1      name of the client which has started a  
command on the AML/J which cannot be  
executed

### DAS ACI Message

EHICAPINUSE

### Explanation

The robotic controller in the AML/J system is switched off while the door (HICAP) is open. DAS holds all outstanding robot commands in the command queue but does not accept any new commands.

### User Activities

- Organize your operation so that no commands are sent to the AML/J while the I/O unit (HICAP) is being configured.
- Inform all other connected users before opening the HICAP.

---

---

## DAS3023

*AMU and DAS not ready for client %1 because switch is in progress.*

param %1     name of the client which has started a command on the AML system that cannot be executed

### DAS ACI Message

ESWITCHINPROG

### Explanation

DAS has been informed by the AMS that the passive AMU is now active. No new commands will be accepted during this switching phase, but those already in the command queue will be processed.

### User Activities

- Inform all affected users before using the switch command.
- Repeat the rejected command once the switching procedure is complete.

## DAS3500

*No clean volser of media type %1 found.*

param %1     cleaning cartridge media type not available.

### DAS ACI Message

ENOTFOUND

### Explanation

Error message from DAS 1.3., which controls DAS drive cleaning; this task has been taken over by AMS from DAS version 3.0.

---

---

## User Activities

- Remove all lines referring to drive cleaning from the *config* file and restart DAS.
- Contact the ADIC/GRAU Storage Systems Customer Help Desk should the error continue to occur.

## DAS3501

*Ejecting clean volser %1*

param %1     volser for the cleaning cartridge

## DAS ACI Message

EOK

## Explanation

Message from DAS 1.3., which controls DAS drive cleaning; this task has been taken over by the AMU.

## User Activities

- Remove all lines referring to drive cleaning from the *config* file and restart DAS.
- Contact the ADIC/GRAU Storage Systems Customer Help Desk should this situation continue to arise.

## DAS3502

*Cleaning drive %1 with volser %2.*

param %1     name of the drive being cleaned  
param %2     volser for the cleaning cartridge

## DAS ACI Message

EOK

## Explanation

Message from DAS 1.3., which controls DAS drive cleaning; this task has been taken over by the AMU.

---

---

## User Activities

- Remove all lines referring to drive-cleaning from the *config* file
- Contact the ADIC/GRAU Storage Systems Customer Help Desk should this situation continue to arise.

## DAS3503

*Cleaning drive %1 with volser %2 ended.*

param %1     name of the drive being cleaned  
param %2     volser for the cleaning cartridge

## DAS ACI Message

EOK

## Explanation

Message from DAS 1.3., which controls DAS drive cleaning; this task has been taken over by the AMU

## User Activities

- Remove all lines referring to drive cleaning from the *config* file and restart DAS.
- Contact the ADIC/GRAU Storage Systems Customer Help Desk should this situation continue to arise.

## DAS3504

*Cleaning drive %1 with volser%2 failed.*

param %1     name of the drive being cleaned  
param %2     volser for the cleaning cartridge

## DAS ACI Message

EOK

## Explanation

Error message from DAS 1.3., which controls DAS drive cleaning; this task has been taken over by the AMU.

---

---

## User Activities

- Remove all lines referring to drive cleaning from the *config* file and restart DAS.
- Contact the ADIC/GRAU Storage Systems Customer Help Desk should the error continue to occur.

## DAS4000

*Client %1 not defined to DAS.*

param %1      client name taken from the environment variable of the ACI that has initiated the command.

## DAS ACI Message

EBADCLIENT

## Explanation

DAS/2 has received a command from a client not configured in DAS. The command is rejected.

## User Activities

- Check whether the client name is specified in the *config* file using the same conventions (lowercase/uppercase) and whether DAS was restarted following the last amendment to the *config* file, or if the client is configured temporarily using the *scap* command.
- Check the client's environment variables and the setting in the application which uses the ACI.
- Contact the ADIC/GRAU Storage Systems Customer Help Desk should the error continue to occur.

## DAS4001

*Client %1 IP address not defined to DAS.*

param %1      clientname taken from the environment variable of the ACI that has initiated the command.

## DAS ACI Message

ENOTAUTH

---

---

## Explanation

DAS/2 has received a command from a client which is entered in the DAS configuration with a different IP address. The command is rejected.

## User Activities

- Check whether the host name or the IP address is specified in the *config* file and whether DAS was restarted following the last amendment to the *config* file, or if the client has been temporarily configured using the **scap** command.
- Check the client's environment variables and the setting in the application which uses the ACI.
- Check the resolution of the host names (hosts file, domain name server)
- Contact the ADIC/GRAU Storage Systems Customer Help Desk should the error continue to occur.

## DAS4002

*Client %1 does not have the required access privilege.*

param %1      client name from the environment variable of the ACI initiating the command.

## DAS ACI Message

ENOTAUT

## Explanation

DAS/2 has received a command from a client without authorization. The client has restricted access privileges only. The command is rejected.

## User Activities

- Check the client configuration in the *config* file.
- If necessary, change the statement requests for the client from restricted to complete. Restart DAS/2 following the changes.



---

---

## DAS4003

*Requested client %1 not defined to DAS.*

param %1     client name specified in the command as a  
                 parameter

### DAS ACI Message

EBADCLIENT

### Explanation

The client name was not found when the parameter was compared with the DAS configuration.

### User Activities

- Check whether the client name is specified in the *config* file using the same conventions (lowercase/uppercase) and whether DAS was restarted following the last amendment to the config file, or if the client has been temporarily configured using the **scap** command.
- Contact the ADIC/GRAU Storage Systems Customer Help Desk should the error continue to occur.

## DAS4004

*Requested drive %1 not defined.*

param %1     drive name (description from the AMS  
                 configuration)

### DAS ACI Message

ENODRIVE

### Explanation

DAS/2 has received a command for a drive that is not defined for the client. The command is rejected.

---

---

## User Activities

- Check whether the drive name is specified in the config file and whether DAS was restarted following the last amendment to the config file, or if the client has been temporarily configured using the **scap** command.
- Repeat the command when the configuration has been modified.
- Contact the ADIC/GRAU Storage Systems Customer Help Desk should the error continue to occur.

## DAS4005

*Requested volser %1 not defined.*

param %1     volser from the command

## DAS ACI Message

ENOVOLUME

## Explanation

DAS/2 has received a command for a volser which is not defined for the client or has not been found in the AMU database.

## User Activities

- Check whether the volser is located in the ranges specified for the client in the *config* file and whether DAS was restarted following the last amendment to the *config* file, or if the client has been temporarily configured using the **scap** command.
- Check the remaining parameters in the command, such as media type and pool name, and whether the volser with the relevant media type exists in the AMU database.
- Repeat the command when the configuration has been modified.
- Contact the ADIC/GRAU Storage Systems Customer Help Desk should the error continue to occur.

---

---

## DAS4006

*Requested area %1 not defined.*

param %1     logical range in the I/O unit (e.g. I03)

### DAS ACI Message

ENOAREA

### Explanation

DAS/2 has received a command for a logical range in the I/O unit which is not defined for the client. The command is rejected.

### User Activities

- Check whether the name of the range is specified in the *config* file and whether DAS was restarted following the last amendment to the *config* file, or if the client has been temporarily configured using the **scap** command.
- Repeat the command when the configuration has been modified.
- Contact the ADIC/GRAU Storage Systems Customer Help Desk should the error continue to occur.

## DAS4007

*Requested pool %1 not defined.*

param %1     name of the scratch pool

### DAS ACI Message

ENOTFOUND

### Explanation

DAS/2 has received a command for a scratch pool that is not defined for the client. The command is rejected.

---

---

## User Activities

- Check whether the name of the scratch pool is specified in the *config* file and whether DAS was restarted following the last amendment to the *config* file, or if the client has been temporarily configured using the **scap** command.
- Repeat the command when the configuration has been modified.
- Contact the ADIC/GRAU Storage Systems Customer Help Desk should the error continue to occur.

## DAS4010

*Client %1 does not have access to volser %2.*

param %1     client name from the environment variable of  
                  the ACI initiating the command.

param %2     volser from the command

## DAS ACI Message

ENOTAUT

## Explanation

DAS/2 has received a command for a volser that is not defined for the client.

## User Activities

- Check whether the volser is located in the ranges specified for the client in the *config* file and whether DAS was restarted following the last amendment to the *config* file, or if the client has been temporarily configured using the **scap** command.
- Repeat the command when the configuration has been modified.
- Contact the ADIC/GRAU Storage Systems Customer Help Desk should the error continue to occur.

---

---

## DAS4011

*Client %1 does not have access to drive %2.*

param %1 client name from the environment variable of the ACI initiating the command.

param %2 drive name (description from the AMS configuration) from the command

### DAS ACI Message

ENOTAUTH

### Explanation

DAS/2 has received a command for a drive that is not defined for the client. The command is rejected.

### User Activities

- Check whether the drive name is specified in the *config* file and whether DAS was restarted following the last amendment to the *config* file, or if the client has been temporarily configured using the **scap** command.
- Repeat the command when the configuration has been modified.
- Contact the ADIC/GRAU Storage Systems Customer Help Desk should the error continue to occur.

## DAS4012

*Client %1 does not have access to area %2.*

param %1 client name from the environment variable of the ACI initiating the command.

param %2 logical range in the I/O unit (e.g. I03)

### DAS ACI Message

ENOAUTH

### Explanation

DAS/2 has received a command for a logical range in the I/O unit which is not defined for the client. The command is rejected.

---

---

## User Activities

- Check whether the name of the range is specified in the *config* file and whether DAS was restarted following the last amendment to the *config* file, or if the client has been temporarily configured using the **scap** command.
- Repeat the command when the configuration has been modified.
- Contact the ADIC/GRAU Storage Systems Customer Help Desk should the error continue to occur.

## DAS4013

*Client %1 does not have access to pool %2.*

param %1     client name from the environment variable of  
                 the ACI initiating the command.

param %2     name of the scratch pool

## DAS ACI Message

ENOTFOUND

## Explanation

DAS/2 has received a command for a scratch pool that is not defined for the client. The command is rejected.

## User Activities

- Check whether the name of the scratch pool is specified in the *config* file and whether DAS was restarted following the last amendment to the *config* file, or if the client has been temporarily configured using the **scap** command.
- Repeat the command when the configuration has been modified.
- Contact the ADIC/GRAU Storage Systems Customer Help Desk should the error continue to occur.

---

---

## DAS4020

*Register request from client %1 for client %2.*

param %1    client name from the environment variable of  
                 the ACI initiating the command.  
param %2    client name from the command

### DAS ACI Message

EOK

### Explanation

DAS/2 has received a command to change the parameters for a client temporarily. DAS/2 records this amended situation temporarily until the next time DAS is started or the AMU is switched off.

### User Activities

This is a notification message. No user activities are necessary.

## DAS4021

*Register request form client %1 completed %2.*

param %1    client name from the environment variable of  
                 the ACI initiating the command.  
param %2    *successful or not successful*

### DAS ACI Message

EOK

### Explanation

DAS/2 has terminated the registration command.

### User Activities

This is a notification message. No user activities are necessary if the command was successful. If the message contains “with failure”, an error has occurred, the cause of which is given in another log message.

---

---

## DAS4022

*Requested client %1 still defined to DAS.*

### DAS ACI Message

EBADCLIENT

### Explanation

DAS/2 has received the command to temporarily redefine an already defined client. The command is rejected.

### User Activities

- Check whether the client is specified in the *config* file and whether DAS was restarted following the last amendment to the *config* file, or if the client has been temporarily configured using the **scap** command.
- Repeat the command when you have modified the configuration.
- Contact the ADIC/GRAU Storage Systems Customer Help Desk should the error continue to occur.

## DAS4023

*Add request for client %1 failed (MAXCLIENT).*

param %1      client name from the environment variable of the ACI initiating the command.

### DAS ACI Message

ENOSPACE

### Explanation

DAS/2 has received a command to temporarily add a client to the DAS configuration. The command has been rejected because the maximum number of clients has been exceeded. The client can only be added by altering the configuration (*config* file).

### User Activities

Modify the configuration:



- 
- 
- Remove a client that may not be need, or is not need at present
  - Obtain the licence for additional clients
  - Delete unneeded clients from the *config* file and specify the new client in its place.
  - Restart the client.
  - Contact the ADIC/GRAU Storage Systems Customer Help Desk should the error continue to occur.

## DAS4024

*The IP address or hostname %1 is not valid.*

param %1      TCP/IP address or host name which can be resolved through the OS/2 TCP/IP software.

## DAS ACI Message

EBADHOST

## Explanation

DAS/2 has received a command with an invalid TCP/IP address or host name. The host name or the IP address is not defined in DAS (temporarily or in the *config* file) or the host name cannot be resolved by the TCP/IP configuration. The command is rejected.

## User Activities

- Check whether the TCP/IP address or host name is specified in the *config* file and whether DAS was restarted following the last amendment to the *config* file, or if the client has been temporarily configured using the **scap** command.
- Repeat the command when the configuration has been modified.
- Contact the ADIC/GRAU Storage Systems Customer Help Desk should the error continue to occur.

---

---

## DAS4030

*Client access request from client %1 for client %2.*

param %1    client name from the environment variable of  
                 the ACI initiating the command.

param %2    client name from the command

### DAS ACI Message

EOK

### Explanation

DAS/2 has received the command to change the access privileges of a client.

### User Activities

This is a notification message. No user activities are necessary.

## DAS4031

*Client access request from client %1 completed %2.*

param %1    client name from the environment variable of  
                 the ACI initiating the command.

param %2    *successful or not successful*

### DAS ACI Message

EOK

### Explanation

DAS/2 has completed the command to change the access privileges.

### User Activities

This is a notification message. No user activities are necessary if the command was successful. If the message contains “with failure”, an error has occurred, the cause of which is given in another log message.

---

---

## **DAS4032**

*Volser range request failed for client %1 (MAXRANGE).*

param %1      client name from the environment variable of  
the ACI initiating the command.

### **DAS ACI Message**

ENOSPACE

### **Explanation**

DAS/2 has received the command to add an additional volser range to the configuration. The maximum number of 10 volser ranges is already defined. The command is rejected.

### **User Activities**

- Check the number of volser ranges defined for the client. Delete unneeded volser ranges.
- Modify the definition so that the limit of 10 volser ranges is not exceeded (e.g. ( 100001, 100002, 100003, 100004, 200001, 200002,200003)) instead of ((100001 - 100004) , (200001 - 200003)).
- Contact the ADIC/GRAU Storage Systems Customer Help Desk should the error continue to occur.

## **DAS4033**

*Volser range %1 not defined for client %2.*

param %1      volser range from the command  
param %2      client name from the environment variable of  
the ACI initiating the command.

### **DAS ACI Message**

ENOTFOUND

### **Explanation**

DAS/2 has received a command to return a list containing volsers within a range. However, the range is not defined for the client. The command is rejected.

---

---

## User Activities

- Check whether the volser is located in the ranges specified for the client in the *config* file and whether DAS was restarted following the last amendment to the *config* file, or if the client has been temporarily configured using the **scap** command.
- Repeat the command when you have modified the configuration.
- Contact the ADIC/GRAU Storage Systems Customer Help Desk should the error continue to occur.

## DAS4040

*Drive access request from client %1 for drive %2 - %3.*

param %1     client name from the environment variable of  
                 the ACI initiating the command.  
param %2     first drive from the command  
param %3     second drive from the command

## DAS ACI Message

EOK

## Explanation

DAS/2 has received a command to change the access privileges of drives in order to change the configuration temporarily.

## User Activities

This is a notification message. No user activities are necessary.

## DAS4041

*Drive access request from client %1 completed %2.*

param %1     client name from the environment variable of  
                 the ACI initiating the command.  
param %2     *successful or not successful*

## DAS ACI Message

EOK

---

---

## Explanation

DAS/2 has completed the command to change the drive access privileges.

## User Activities

This is a notification message. No user activities are necessary if the command was successful. If the message contains “with failure”, an error has occurred, the cause of which is given in another log message.

## DAS4042

*Drive %1 in use by another client.*

param %1     drive name from the command

## DAS ACI Message

EUPELSE

## Explanation

DAS/2 has received a command to change the access privileges for the drives. However, the drive specified is presently occupied by another client. The command is rejected.

## User Activities

- Use **listd** to check which client is currently using the drive
- Initiate a **dismount** on the drive
- Agree with this user the times when a certain drive is used and by whom
- Vacate the drive immediately you have finished using it
- Contact the ADIC/GRAU Storage Systems Customer Help Desk should the error continue to occur.

---

---

## DAS4043

*Drive %1 not owned by client %2*

param %1     drive name from the command  
param %2     client name from the command

### DAS ACI Message

EUPELSE

### Explanation

DAS/2 has received a command to change the access privileges for the drives. However, the drive specified is not defined for the client. The command is rejected.

### User Activities

- Check whether the drive name is specified in the *config* file and whether DAS was restarted following the last amendment to the *config* file, or if the client has been temporarily configured using the **scap** command.
- Repeat the command when you have modified the configuration.
- Contact the ADIC/GRAU Storage Systems Customer Help Desk should the error continue to occur.

## DAS4044

*Drive %1 is not empty.*

param %1     drive name from the command

### DAS ACI Message

EDRVOCCUPIED

### Explanation

DAS/2 has received a command to change the access privileges for a drive to DOWN. However, the specified drive is presently occupied by another client. The command is rejected.

---

---

## User Activities

- Use **listd** to check which client is currently using the drive
- Initiate a dismount on the drive
- Agree with this user the times when a certain drive is used and by whom
- Vacate the drive immediately whenever you have finished using it
- Contact the ADIC/GRAU Storage Systems Customer Help Desk should the error continue to occur.

## DAS4045

*Drive %1 is exclusive up for another Client.*

param %1     drive name from the command

## DAS ACI Message

EEXUP

## Explanation

DAS/2 has received a command to change the access privileges for a drive to DOWN. However, the specified drive is presently exclusively occupied by another client. The command is rejected.

## User Activities

- Use **listd** to check which client is currently using the drive
- Initiate a dismount on the drive
- Agree with this user the times when a certain drive is used and by whom
- Vacate the drive immediately whenever you have finished using it (the exclusively occupied drive can only be vacated by the client that has occupied it or by the DAS\_SUPERVISOR client).
- Contact the ADIC/GRAU Storage Systems Customer Help Desk should the error continue to occur.

---

---

## DAS4050

*Foreign request from client %1 - coordinate %2, volser %3.*

param %1     client name from the environment variable of  
                  the ACI initiating the command.  
param %2     10-digit coordinate from the command  
param %3     volser cataloged as foreign mount.

### DAS ACI Message

EOK

### Explanation

DAS/2 has received a command to change the access privileges of drives in order to change the configuration temporarily.

### User Activities

This is a notification message. No user activities are necessary.

## DAS4051

*Foreign request from client %1 completed %2.*

param %1     client name from the environment variable of  
                  the ACI initiating the command.  
param %2     *successful or with failure (%3)*  
param %3     ACI error number

### DAS ACI Message

EOK

### Explanation

DAS/2 has received the command to catalog a foreign-mount medium.

### User Activities

This is a notification message. No user activities are necessary if the command was successful. If the message contains “with failure”, an error has occurred, the cause of which is given in another log message.



---

---

## DAS4052

*Foreign volser %1, media type %2 added to DAS catalog.*

param %1    volser cataloged as foreign mount.  
param %2    media type of the foreign-mount slot

### DAS ACI Message

EOK

### Explanation

DAS/2 has executed the command to catalog a foreign-mount medium.

### User Activities

This is a notification message. No user activities are necessary.

## DAS4053

*Foreign volser %1, media type %2 not stored in DAS catalog.*

param %1    volser which is specified as foreign mount in  
                  the command.  
param %2    media type in the command or environment  
                  variable

### DAS ACI Message

ENOVOLUME

### Explanation

Due to an error, the volser was not registered by DAS/2 as foreign mount in the *dasdata.ini* file during the **catf** command. The specified volser was not found in the *dasdata.ini* file during an **rmf** command, and the command was not executed.

### User Activities

Check that the media type and volser have been correctly specified in the command. There is no option in DAS for displaying the cataloged foreign-mount media.

- 
- 
- All cataloged foreign-mount media can be removed by deleting the *dasdata.ini* file (hidden in the directory). This will reset the current assignment of drives to clients (**allood**) and the volser allocation.
  - Contact the ADIC/GRAU Storage Systems Customer Help Desk should the error continue to occur.

## **DAS4054**

*Coordinate %1 not empty for foreign volser %2.*

param %1    10-digit coordinate from the command  
param %2    volser cataloged as foreign mount.

### **DAS ACI Message**

ENOSPACE

### **Explanation**

DAS/2 has received a command to catalog a foreign-mount volser but the slot is occupied or not available. The command is rejected.

### **User Activities**

- Check the specification of the coordinates in the DAS command.
- Compare the coordinates in the AMS.
- Change the status to empty if the slot for the new foreign-mount volser is still free.
- Contact the ADIC/GRAU Storage Systems Customer Help Desk should the error continue to occur.

## **DAS4055**

*Coordinate %1 is not of type FOREIGN.*

param %1    10-digit coordinate from the command

### **DAS ACI Message**

ENOMATCH

---

---

## Explanation

DAS/2 is receiving a command to catalog a foreign-mount volser but the slot is not of the foreign type. The command is rejected.

## User Activities

- Check the specification of the coordinates in the DAS command.
- Compare the coordinates in the AMS.
- Change the type to foreign in the AMS configuration if the slot is to be used for a new foreign-mount volser. Activate the changes after saving the configuration using Update EIF.
- Contact the ADIC/GRAU Storage Systems Customer Help Desk should the error continue to occur.

## DAS4056

*Coordinate %1 does not match media type %2.*

param %1    10-digit coordinate from the command  
param %2    media type

## DAS ACI Message

ENOMATCH

## Explanation

While cataloguing a foreign-mount volser, DAS/2 has detected that the slot (AMU database) does not match the media type in the command (environment variable).

## User Activities

- Check the command and the environment variable.
- Compare the specification with the AMS configuration (media type in the graphical configuration of the I/O unit).
- Contact the ADIC/GRAU Storage Systems Customer Help Desk should the error continue to occur.

---

---

## DAS4057

*Foreign volser %1 still mounted.*

param %1     volser cataloged as foreign mount.

### DAS ACI Message

EINUSE

### Explanation

DAS/2 is to delete a foreign-mount volser, although the volser is presently in the drive. The command is rejected.

### User Activities

- Check the volser in the command.
- Execute a **dismount** and remove the medium from the AML system before deleting the foreign-mount volser.
- Contact the ADIC/GRAU Storage Systems Customer Help Desk should the error continue to occur.

## DAS4060

*Mount request from client %1 - volser %2, drive %3.*

param %1     client name from the environment variable of the ACI initiating the command.

param %2     volser from the mount command

param %3     name of drive in which the mount is executed.

### DAS ACI Message

EOK

### Explanation

DAS/2 has received a command to execute a mount.

### User Activities

This is a notification message. No user activities are necessary.

---

---

## DAS4061

*Mount request from client %1 completed %2.*

param %1     client name from the environment variable of  
                 the ACI initiating the command.  
param %2     *successful* or *with failure* (%3)  
param %3     ACI error number

### DAS ACI Message

EOK

### Explanation

DAS/2 has terminated the **mount** command.

### User Activities

This is a notification message. No user activities are necessary if the command was successful. If the message contains “with failure”, an error has occurred, the cause of which is given in another log message.

## DAS4062

*Drive %1 not active for client %2.*

param %1     drive name from the command  
param %2     client name from the environment variable of  
                 the ACI initiating the command.

### DAS ACI Message

ENODRIVE

### Explanation

DAS/2 is to execute a mount for a client but the selected drive is not assigned (UP or EXUP status) for this client.

### User Activities

- Check the drive name in the command.
- Compare the name with the list of drives (**listd**)
- Change the drive status to UP if necessary (**allocd**); this process is not executed automatically by all applications.
- Vacate the drive if it is already occupied by another client.

- 
- 
- Contact the ADIC/GRAU Storage Systems Customer Help Desk should the error continue to occur.

## DAS4063

*Drive %1 does not match type %2 for volser %3.*

param %1     drive name from the command  
param %2     media type of the volser %3 from the  
                  command or environment variable  
param %3     volser from the command

## DAS ACI Message

ENODRIVE

## Explanation

While executing the command, DAS/2 has detected that the slot (AMU database) does not match the media type in the command (environment variable).

## User Activities

- Check the command and the environment variable.
- Compare the specification with the AMS configuration (media type in the graphical configuration of the I/O unit).
- Contact the ADIC/GRAU Storage Systems Customer Help Desk should the error continue to occur.

## DAS4064

*Drive(s) 1 not available for mount request from client %1.*

param %1     client name from the environment variable of  
                  the ACI initiating the command.

## DAS ACI Message

ENODRIVE

## Explanation

DAS/2 has received an uncommitted mount request but has no assigned free drive available for the specified media type.

---

---

## User Activities

- Check the command (media type, volser)
- Assign the necessary drives.
- The *no\_dismount* option must be set in the *config* file if your application does not generate the **dismount** command.
- Contact the ADIC/GRAU Storage Systems Customer Help Desk should the error continue to occur.

## DAS4065

*Drive %1 is currently being cleaned.*

param %1     drive name in the command

## DAS ACI Message

EDRVOCCUPIED

## Explanation

DAS/2 has received a **mount** command although drive-cleaning is presently in progress. The command is rejected.

## User Activities

- Wait until the cleaning process has finished and then repeat the command.
- Contact the ADIC/GRAU Storage Systems Customer Help Desk should the error continue to occur.

## DAS4066

*Volser %1 not found in Drive-Volser attachment list.*

param %1     volser from the command

## DAS ACI Message

ENOTFOUND

## Explanation

DAS/2 has received a **mount** command to a drive for which the volser is not authorized. The command is rejected.





---

---

## Explanation

DAS/2 has terminated the **mount** command.

## User Activities

This is a notification message. No user activities are necessary if the command was successful. If the message contains “with failure”, an error has occurred, the cause of which is given in another log message.

## DAS4072

*Volser %1 not mounted.*

param %1     volser from the command

## DAS ACI Message

ENOTMOUNTED

## Explanation

DAS/2 is to unload a volser from the drive, although the volser is not in a drive (AMU database)

## User Activities

- Check the command (volser)
- Check the volser with the entries in the AMU database and check the drive at its location
- Check the dismount manager setting.
- Contact the ADIC/GRAU Storage Systems Customer Help Desk should the error continue to occur.

## DAS4080

*Insert request from client %1 for area %2.*

param %1     client name from the environment variable of the ACI initiating the command.

param %2     name of the logical insertion field from the command

## DAS ACI Message

EOK

---

---

## Explanation

DAS/2 is receiving the command to execute an insertion.

## User Activities

This is a notification message. No user activities are necessary.

## DAS4081

*Insert request from client %1 completed %2.*

param %1     client name from the environment variable of the ACI initiating the command.

param %2     *successful or with failure (%3)*

param %3     ACI error number

## DAS ACI Message

EOK

## Explanation

DAS/2 has terminated the **insert** command.

## User Activities

This is a notification message. No user activities are necessary if the command was successful. If the message contains “with failure”, an error has occurred, the cause of which is given in another log message.

## DAS4082

*Area %1 is not an insert area.*

param %1     name of the logical insertion field from the command

## DAS ACI Message

ENOAREA

## Explanation

DAS/2 has received a command to a logical range in the I/O unit which is not defined as an insertion range in the AMS configuration. The command is rejected.

---

---

## User Activities

- Check the range name in the command (e.g. I01)
- Compare these names with those specified in the I/O unit configuration in the AMS; repeat the command when the configuration has been updated
- Contact the ADIC/GRAU Storage Systems Customer Help Desk should the error continue to occur.

## DAS4090

*Eject request from client %1 - volser %2, area %3.*

param %1 client name from the environment variable of the ACI initiating the command.

param %2 volser from the command

param %3 name of the logical ejection field from the command

## DAS ACI Message

EOK

## Explanation

DAS/2 is receiving the command to execute an eject.

## User Activities

This is a notification message. No user activities are necessary.

## DAS4091

*Eject request from client %1 completed %2.*

param %1 client name from the environment variable of the ACI initiating the command.

param %2 *successful* or *with failure* (%3)

param %3 ACI error number

## DAS ACI Message

EOK

## Explanation

DAS/2 has terminated the **insert** command.

---

---

## User Activities

This is a notification message. No user activities are necessary if the command was successful. If the message contains “with failure”, an error has occurred, the cause of which is given in another log message.

## DAS4092

*Area %1 is not an eject area.*

param %1      name of the logical ejection field from the command

## DAS ACI Message

ENOAREA

## Explanation

DAS/2 has received a command to a logical range in the I/O unit which is not defined as an ejection range in the AMS configuration. The command is rejected.

## User Activities

- Check the range name in the command (e.g. E01)
- Compare these names with those specified in the I/O unit configuration in the AMS; repeat the command when the configuration has been updated.
- Contact the ADIC/GRAU Storage Systems Customer Help Desk should the error continue to occur.

## DAS4093

*Area %1 cannot store media type %2.*

param %1      name of the logical ejection field from the command

param %2      media type from the command or environment variable

## DAS ACI Message

ENOMATCH

---

---

## Explanation

While executing the command, DAS/2 has detected that the slot (AMU database) does not match the media type in the command (environment variable).

## User Activities

- Check the command and the environment variable.
- Compare the specification with the AMS configuration (media type in the graphical configuration of the I/O unit).
- Contact the ADIC/GRAU Storage Systems Customer Help Desk should the error continue to occur.

## DAS4094

*Volser %1 not available.*

param %1     volser from the command

## DAS ACI Message

ENOVOLUME

## Explanation

DAS/2 is receiving an **eject** command on a volser which is not registered in the AMU database or is not in its home position. The command is rejected.

## User Activities

- Check
  - the volser in the command
  - whether the volser is located in its home position
  - whether the AMU database entries are correct
- Repeat the command
  - when the volser is located in its home position
  - when the database entries are correct

- 
- 
- Contact the ADIC/GRAU Storage Systems Customer Help Desk should the error continue to occur.

## DAS4095

*Volser %1 does not match media type %2.*

param %1     volser from the command  
param %2     media type

### DAS ACI Message

ENOMATCH

### Explanation

DAS/2 is receiving a command on a volser whose media type in the database does not match the media type in the command.

### User Activities

- Check
  - the media type in the command
  - the volser in the command
- Check whether the volser may be registered a second time in the AMU database under another media type
- Compare the media type with the AMS configuration
- Repeat the command with the correct media type
- Contact the ADIC/GRAU Storage Systems Customer Help Desk should the error continue to occur.

## DAS4096

*Eject area %1 is full. Please empty...*

param %1     name of the logical ejection field from the  
                  command

### DAS ACI Message

EOK

---

---

## Explanation

DAS/2 is receiving an **eject** command on a volsers for whose media type there is no slot or no free slot in the ejection range of the AMU database. The command remains in the command queue until a range is made available.

## User Activities

- Check the ejection range.
- Remove the cartridges occupying the ejection range in the I/O unit.
- Correct the configuration if the ejection range does not match the media type
- Repeat the command on the correct ejection range
- Contact the ADIC/GRAU Storage Systems Customer Help Desk should the error continue to occur.

## DAS4100

*Inventory request from client %1.*

param %1      client name from the environment variable of the ACI initiating the command.

## DAS ACI Message

EOK

## Explanation

DAS/2 has received an **inventory** command. The command is executed in the background at low priority. However, the client receives confirmation that the command has started.

## User Activities

This is a notification message. No user activities are necessary.

The **inventory** command is intended only for servicing or starting up, not as a normal command to be used during processing. If there is a problem with barcode reading, then the volsers in the database are overwritten by volsers signifying that the barcode is illegible (e.g. \*I0001).



---

---

## DAS4101

*Inventory request from client %1 completed %2.*

param %1     client name from the environment variable of  
                 the ACI initiating the command.  
param %2     *successful or with failure (%3)*  
param %3     ACI error number

### DAS ACI Message

EOK

### Explanation

DAS/2 has terminated the **inventory** command. The client is not informed of this

### User Activities

This is a notification message. No user activities are necessary if the command was successful. If the message contains “with failure”, an error has occurred, the cause of which is given in another log message.

## DAS4102

*Inventory request already active.*

### DAS ACI Message

EINUSE

### Explanation

DAS/2 is receiving the **inventory** command although there is another **inventory** command already active. The command is rejected.

### User Activities

If you want to restart the inventory:

- Determining the sequence number using **list**
- Delete the sequence number using **cancel**
- Now start the **inventory** command
- Contact the ADIC/GRAU Storage Systems Customer Help Desk should the error continue to occur.



---

---

## DAS4110

*List request from client %1.*

param %1     client name from the environment variable of  
                 the ACI initiating the command.

### DAS ACI Message

EOK

### Explanation

DAS/2 is receiving the command to execute **list**.

### User Activities

This is a notification message. No user activities are necessary.

## DAS4111

*List request from client %1 completed %2.*

param %1     client name from the environment variable of  
                 the ACI initiating the command.

param %2     *successful* or *with failure* (%3)

param %3     ACI error number

### DAS ACI Message

EOK

### Explanation

DAS/2 has terminated the **list** command.

### User Activities

This is a notification message. No user activities are necessary if the command was successful. If the message contains “with failure”, an error has occurred, the cause of which is given in another log message.

---

---

## DAS4120

*Cancel request from client %1.*

param %1     client name from the environment variable of  
                 the ACI initiating the command.

### DAS ACI Message

EOK

### Explanation

DAS/2 is receiving the command to execute **Cancel**.

### User Activities

This is a notification message. No user activities are necessary.

## DAS4121

*Cancel request from client %1 completed %2.*

param %1     client name from the environment variable of  
                 the ACI initiating the command.

param %2     *successful or with failure (%3)*

param %3     ACI error number

### DAS ACI Message

EOK

### Explanation

DAS/2 has terminated the **Cancel** command.

### User Activities

This is a notification message. No user activities are necessary if the command was successful. If the message contains “with failure”, an error has occurred, the cause of which is given in another log message.

---

---

## DAS4130

*Shutdown request from client %1.*

param %1     client name from the environment variable of  
                 the ACI initiating the command.

### DAS ACI Message

EOK

### Explanation

DAS/2 is receiving the command to execute **shutdown**.

### User Activities

This is a notification message. No user activities are necessary.

## DAS4131

*Shutdown request from client %1 completed %2.*

param %1     client name from the environment variable of  
                 the ACI initiating the command.  
param %2     *successful* or *with failure* (%3)  
param %3     ACI error number

### DAS ACI Message

EOK

### Explanation

DAS/2 has accepted the **shutdown** command; DAS/2 will  
shut down in a few seconds.

### User Activities

This is a notification message. No user activities are necessary  
if the command was successful. If the message contains “with  
failure”, an error has occurred, the cause of which is given in  
another log message.

---

---

## DAS4140

*Drive status request from client %1.*

param %1     client name from the environment variable of  
                 the ACI initiating the command.

### DAS ACI Message

EOK

### Explanation

DAS/2 is receiving the **listd** or **listd2** command.

### User Activities

This is a notification message. No user activities are necessary.

## DAS4141

*Drive status request from client %1 completed %2.*

param %1     client name from the environment variable of  
                 the ACI initiating the command.  
param %2     *successful or with failure (%3)*  
param %3     ACI error number

### DAS ACI Message

EOK

### Explanation

DAS/2 has terminated the **list2** command.

### User Activities

This is a notification message. No user activities are necessary if the command was successful. If the message contains “with failure”, an error has occurred, the cause of which is given in another log message.

---

---

## DAS4150

*Client status request from client %1 for client %2.*

param %1    client name from the environment variable of  
                 the ACI initiating the command.  
param %2    client name from the command

### DAS ACI Message

EOK

### Explanation

DAS/2 is receiving the command to execute **show**.

### User Activities

This is a notification message. No user activities are necessary.

## DAS4151

*Drive status request from client %1 completed %2.*

param %1    client name from the environment variable of  
                 the ACI initiating the command.  
param %2    *successful* or *with failure* (%3)  
param %3    ACI error number

### DAS ACI Message

EOK

### Explanation

DAS/2 has terminated the **show** command.

### User Activities

This is a notification message. No user activities are necessary if the command was successful. If the message contains “with failure”, an error has occurred, the cause of which is given in another log message.

---

---

## DAS4160

*DAS version request from client %1.*

param %1      client name from the environment variable of  
the ACI initiating the command.

### DAS ACI Message

EOK

### Explanation

DAS/2 is receiving the command to execute `qversion`.

### User Activities

This is a notification message. No user activities are necessary.

## DAS4161

*DAS version request from client %1 completed %2.*

param %1      client name from the environment variable of  
the ACI initiating the command.  
param %2      *successful or with failure (%3)*  
param %3      ACI error number

### DAS ACI Message

EOK

### Explanation

DAS/2 has terminated the `qversion` command.

### User Activities

This is a notification message. No user activities are necessary if the command was successful. If the message contains “with failure”, an error has occurred, the cause of which is given in another log message.

---

---

## DAS4170

*Volser range request from client %1.*

param %1    client name from the environment variable of  
                 the ACI initiating the command.

### DAS ACI Message

EOK

### Explanation

DAS/2 is receiving the command to execute **qvolsrange**.

### User Activities

This is a notification message. No user activities are necessary.

## DAS4171

*Volser range request from client %1 completed %2.*

param %1    client name from the environment variable of  
                 the ACI initiating the command.

param %2    *successful* or *with failure* (%3)

param %3    ACI error number

### DAS ACI Message

EOK

### Explanation

DAS/2 has terminated the **qvolsrange** command.

### User Activities

This is a notification message. No user activities are necessary if the command was successful. If the message contains “with failure”, an error has occurred, the cause of which is given in another log message.

---

---

## DAS4180

*View request from client %1 volser %2.*

param %1     client name from the environment variable of  
                  the ACI initiating the command.  
param %2     volser number requested

### DAS ACI Message

EOK

### Explanation

DAS/2 is receiving the command to execute **view**.

### User Activities

This is a notification message. No user activities are necessary.

## DAS4181

*View request from client %1 completed %2.*

param %1     client name from the environment variable of  
                  the ACI initiating the command.  
param %2     *successful or with failure (%3)*  
param %3     ACI error number

### DAS ACI Message

EOK

### Explanation

DAS/2 has terminated the **view** command.

### User Activities

This is a notification message. No user activities are necessary if the command was successful. If the message contains “with failure”, an error has occurred, the cause of which is given in another log message.



---

---

## DAS4190

*Init request from client %1.*

param %1     client name from the environment variable of  
                 the ACI initiating the command.

### DAS ACI Message

EOK

### Explanation

DAS/2 is receiving the command to execute **init**.

### User Activities

This is a notification message. No user activities are necessary.

## DAS4191

*Init request from client %1 completed %2.*

param %1     client name from the environment variable of  
                 the ACI initiating the command.

param %2     *successful* or *with failure* (%3)

param %3     ACI error number

### DAS ACI Message

EOK

### Explanation

DAS/2 has terminated the **init** command.

### User Activities

This is a notification message. No user activities are necessary if the command was successful. If the message contains “with failure”, an error has occurred, the cause of which is given in another log message.

---

---

## DAS4200

*Scratch request from client %1.*

param %1     client name from the environment variable of  
                 the ACI initiating the command.

### DAS ACI Message

EOK

### Explanation

DAS/2 is receiving a scratch processing command.

### User Activities

This is a notification message. No user activities are necessary.

## DAS4201

*Scratch request from client %1 completed %2.*

param %1     client name from the environment variable of  
                 the ACI initiating the command.

param %2     *successful or with failure (%3)*

param %3     ACI error number

### DAS ACI Message

EOK

### Explanation

DAS/2 has terminated the **scratch** command.

### User Activities

This is a notification message. No user activities are necessary if the command was successful. If the message contains “with failure”, an error has occurred, the cause of which is given in another log message.

---

---

## DAS4204

*Partial Inventory request from client %1, %2 to %3.*

param %1    client name from the environment variable of  
                 the ACI initiating the command.  
param %2    start coordinate from the command  
param %3    end coordinate from the command

### DAS ACI Message

EOK

### Explanation

DAS/2 is receiving a partial **inventory** command.

### User Activities

This is a notification message. No user activities are necessary.

## DAS4205

*Partial Inventory request from client %1 completed %2.*

param %1    client name from the environment variable of  
                 the ACI initiating the command.  
param %2    *successful* or *with failure* (%3)  
param %3    ACI error number

### DAS ACI Message

EOK

### Explanation

DAS/2 has terminated the **PartInventory** command.

### User Activities

This is a notification message. No user activities are necessary if the command was successful. If the message contains “with failure”, an error has occurred, the cause of which is given in another log message.

---

---

## DAS4210

*Switch request from client %1.- Option %2.*

param %1     client name from the environment variable of  
                 the ACI initiating the command.  
param %2     option (**-n** for normal or **-f** for force) from the  
                 command

### DAS ACI Message

EOK

### Explanation

DAS/2 is receiving a **switch** command.

### User Activities

This is a notification message. No user activities are necessary.  
DAS accepts no new commands until this **switch** command  
has ended.

## DAS4211

*Switch request from client %1 completed %2.*

param %1     client name from the environment variable of  
                 the ACI initiating the command.  
param %2     *successful or with failure (%3)*  
param %3     ACI error number

### DAS ACI Message

EOK

### Explanation

DAS/2 has terminated the **switch** command.

### User Activities

This is a notification message. No user activities are necessary  
if the command was successful. If the message contains “with  
failure”, an error has occurred, the cause of which is given in  
another log message.

---

---

## **DAS4220**

*Clean drive request from client %1, for drive %2.*

param %1    client name from the environment variable of  
                 the ACI initiating the command.

param %2    drive name from the command

### **DAS ACI Message**

EOK

### **Explanation**

DAS/2 is receiving a **clean** command.

### **User Activities**

This is a notification message. No user activities are necessary.

---

---

## DAS4221

*Clean drive request from client %1 completed %2.*

param %1     client name from the environment variable of  
                  the ACI initiating the command.  
param %2     *successful or with failure (%3)*  
param %3     ACI error number

### DAS ACI Message

EOK

### Explanation

DAS/2 has terminated the **clean** command.

### User Activities

This is a notification message. No user activities are necessary if the command was successful. If the message contains “with failure”, an error has occurred, the cause of which is given in another log message.

## DAS4230

*EjectClean request from client %1 - cleanpool %2, area %3.*

param %1     client name from the environment variable of  
                  the ACI initiating the command.  
param %2     clean pool name from the command  
param %3     name of the ejection field from the command

### DAS ACI Message

EOK

### Explanation

DAS/2 is receiving a **ejectcl** command.

### User Activities

This is a notification message. No user activities are necessary.

---

---

## DAS4231

*EjectClean request from client %1 completed %2.*

param %1     client name from the environment variable of  
                 the ACI initiating the command.  
param %2     *successful* or *with failure* (%3)  
param %3     ACI error number

### DAS ACI Message

EOK

### Explanation

DAS/2 has terminated the `ejectcl` command.

### User Activities

This is a notification message. No user activities are necessary if the command was successful. If the message contains “with failure”, an error has occurred, the cause of which is given in another log message.

## DAS4232

*Eject area %1 is full. Please empty...*

param %1     name of the logical ejection field from the  
                 command

### DAS ACI Message

EAREAFULL

### Explanation

DAS/2 is receiving an `eject` command for cleaning cartridges for whose media type there is no slot or no free slot in the ejection range of the AMU database. The command remains in the command queue until a range is made available.

### User Activities

- Check the ejection range.
- Remove the cartridges occupying the ejection range in the I/O unit.

- 
- 
- Correct the configuration if the ejection range does not match the media type
  - Repeat the command on the correct ejection range
  - Contact the ADIC/GRAU Storage Systems Customer Help Desk should the error continue to occur.

## DAS4240

*Insertclean request from client %1 - for area %2, and clean-pool %3.*

param %1     client name from the environment variable of the ACI initiating the command.  
param %2     name of the insertion field from the command  
param %3     clean pool name from the command

### DAS ACI Message

EOK

### Explanation

DAS/2 is receiving an **insert** command with the option for cleaning cartridges.

### User Activities

This is a notification message. No user activities are necessary.

## DAS4241

*Insertclean request from client %1 completed %2.*

param %1     client name from the environment variable of the ACI initiating the command.  
param %2     *successful or with failure (%3)*  
param %3     ACI error number

### DAS ACI Message

EOK

### Explanation

DAS/2 has terminated the **insert2** command.



---

---

## User Activities

This is a notification message. No user activities are necessary if the command was successful. If the message contains “with failure”, an error has occurred, the cause of which is given in another log message.

## DAS4242

*Poolname %1 is an invalid Poolname.*

param %1     name of the clean pool from the command

## DAS ACI Message

ENOPOOL

## Explanation

DAS/2 is receiving an **insert** command for cleaning cartridges with a clean pool name that has not been defined. The command is rejected.

## User Activities

- Check the clean pool name in the command.
- Check the configured clean pool names in the AMS and compare the name with the name in the command
- Correct the configuration or the command
- Repeat the command with the correct clean pool name
- Contact the ADIC/GRAU Storage Systems Customer Help Desk should the error continue to occur.

## DAS4250

*Barcode request from client %1.*

param %1     client name from the environment variable of the ACI initiating the command.

## DAS ACI Message

EOK

## Explanation

DAS/2 is receiving a **barcode** command.

---

---

## User Activities

This is a notification message. No user activities are necessary.

## DAS4251

*Barcode request from client %1 completed %2.*

param %1 client name from the environment variable of the ACI initiating the command.

param %2 *successful or with failure (%3)*

param %3 ACI error number

## DAS ACI Message

EOK

## Explanation

DAS/2 has terminated the **barcode** command.

## User Activities

This is a notification message. No user activities are necessary if the command was successful. If the message contains “with failure”, an error has occurred, the cause of which is given in another log message.

## DAS4260

*KillAmu request from client %1.*

param %1 client name from the environment variable of the ACI initiating the command.

## DAS ACI Message

EOK

## Explanation

DAS/2 is receiving a **killamu** command.

## User Activities

This is a notification message. No user activities are necessary.

---

---

## DAS4261

*KillAmu request from client %1 completed %2.*

param %1    client name from the environment variable of  
                 the ACI initiating the command.  
param %2    *successful* or *with failure* (%3)  
param %3    ACI error number

### DAS ACI Message

EOK

### Explanation

DAS/2 has started the **killamu** command. It may be several minutes until the command is completed.

### User Activities

This is a notification message. No user activities are necessary if the command was successful. However, wait 5 minutes before switching off the power supply.

If the message contains “with failure”, an error has occurred, the cause of which is given in another log message.

## DAS4270

*Flip request from client %1.*

param %1    client name from the environment variable of  
                 the ACI initiating the command.

### DAS ACI Message

EOK

### Explanation

DAS/2 is receiving a **flip** command.

### User Activities

This is a notification message. No user activities are necessary.

---

---

## DAS4271

*Flip request from client %1 completed %2.*

param %1      client name from the environment variable of  
                 the ACI initiating the command.  
param %2      *successful or with failure (%3)*  
param %3      ACI error number

### DAS ACI Message

EOK

### Explanation

DAS/2 has terminated the **flip** command.

### User Activities

This is a notification message. No user activities are necessary if the command was successful. If the message contains “with failure”, an error has occurred, the cause of which is given in another log message.

## DAS4272

*Drive %1 isn't a correct drive for this flip request.*

param %1      name of the drive from the command

### DAS ACI Message

ENODRIVE

### Explanation

DAS/2 is receiving a **flip** command for a drive not designed for optical disks and so the **flip** command is not supported. The command is rejected.

### User Activities

- Check the drive name in the command.
- Check the configured drives in the AMS and compare drive configuration with the drive in the command
- Correct the configuration or the command
- Repeat the command with the correct drive

- 
- 
- Contact the ADIC/GRAU Storage Systems Customer Help Desk should the error continue to occur.

## DAS4280

*GetVolToSide request from client %1 - volser: %2.*

param %1     client name from the environment variable of  
                 the ACI initiating the command.

param %2     volser from the command

### DAS ACI Message

EOK

### Explanation

DAS/2 is receiving a **getvoltoside** command.

### User Activities

This is a notification that no user activities are necessary.

## DAS4281

*GetVolToSide request from client %1 completed %2.*

param %1     client name from the environment variable of  
                 the ACI initiating the command.

param %2     *successful* or *with failure* (%3)

param %3     ACI error number

### DAS ACI Message

EOK

### Explanation

DAS/2 has terminated the **getvoltoside** command.

### User Activities

This is a notification message. No user activities are necessary if the command was successful. If the message contains “with failure”, an error has occurred, the cause of which is given in another log message.

---

---

## DAS4282

*Volser %1 isn't a volser with two sides.*

param %1     name of the volser from the command

### DAS ACI Message

ENODOUBLESIDE

### Explanation

DAS/2 is receiving a **gettovolside** command for a volser which has not been found in the AMU database at slots for optical disks. The command is rejected.

### User Activities

- Check the volser in the command.
- Check the configured media types in the AMS for the slot of the volser
- Check that the volser has not been registered twice (additionally for another media type)
- Correct the configuration or the command
- Repeat the command with the correct volser
- Contact the ADIC/GRAU Storage Systems Customer Help Desk should the error continue to occur.

## DAS4290

*Volser access request from client %1 - for volser %2 - %3.*

param %1     client name from the environment variable of the ACI initiating the command.

param %2     first volser of the volser range in the command

param %3     last volser of the volser range in the command

### DAS ACI Message

EOK

### Explanation

DAS/2 is receiving an **allocv** command.

---

---

## User Activities

This is a notification message. No user activities are necessary.

### DAS4291

*Volser access request from client %1 completed %2.*

param %1     client name from the environment variable of  
                 the ACI initiating the command.

param %2     *successful* or *with failure* (%3)

param %3     ACI error number

### DAS ACI Message

EOK

### Explanation

DAS/2 has terminated the **allocv** command.

### User Activities

This is a notification message. No user activities are necessary if the command was successful. If the message contains “with failure”, an error has occurred, the cause of which is given in another log message.

### DAS4292

*Volsers assigned by another client.*

### DAS ACI Message

EUPELSE

### Explanation

DAS/2 is receiving an **allocv** command a volser which has already reserved another client. The command is rejected.

### User Activities

- Check the volser range in the command.
- Check the volser ranges that are already reserved (**listv**) and compare the range with the command. The ranges must not overlap.

- 
- 
- Correct the command
  - Repeat the command with the correct volser range
  - Contact the ADIC/GRAU Storage Systems Customer Help Desk should the error continue to occur.

## DAS4293

*Volsers not owned by client %1.*

param %1      client name from the environment variable of the ACI initiating the command.

### DAS ACI Message

EUPELSE

### Explanation

DAS/2 is receiving an **allocv** command a volser which has no authorization for the client. The command is rejected.

### User Activities

- Check the volser range in the command.
- Check the configuration of the volser ranges in the *config* file and compare the ranges in the command. Correct the command
- Repeat the command with the correct volser range
- Contact the ADIC/GRAU Storage Systems Customer Help Desk should the error continue to occur.

## DAS4295

*Client %1 has already an allocation*

param %1      client name from the environment variable of the ACI initiating the command.

### DAS ACI Message

EUPOWN

### Explanation

DAS/2 is receiving an **allocv** command.

The command is rejected.



---

---



## User Activities

- Check the volser range in the command.
- Check the volser ranges that are already reserved (**listv**) and compare the range with the command. The ranges must not overlap.
- Correct the command
- Repeat the command with the correct volser range
- Contact the ADIC/GRAU Storage Systems Customer Help Desk should the error continue to occur.

---

---

## DAS4296

*Client %1 has no allocation*

param %1     client name from the environment variable of  
                 the ACI initiating the command.

### DAS ACI Message

EUPELSE

### Explanation

DAS/2 is receiving an **allocv** command.

The command is rejected.

### User Activities

- Check the volser range in the command.
- Check the volser ranges that are already reserved (**listv**) and compare the range with the command. The ranges must not overlap.
- Correct the command
- Repeat the command with the correct volser range
- Contact the ADIC/GRAU Storage Systems Customer Help Desk should the error continue to occur.

## DAS4297

*The request is not allowed for the specified Client %1.*

param %1     client name from the environment variable of  
                 the ACI initiating the command.

### DAS ACI Message

EBADCLIENT

### Explanation

DAS/2 is receiving an **allocv** command.

The command is rejected.

---

---

## User Activities

- Check the volser range in the command.
- Check the volser ranges that are already reserved (**listv**) and compare the range with the command. The ranges must not overlap.
- Correct the command
- Repeat the command with the correct volser range
- Contact the ADIC/GRAU Storage Systems Customer Help Desk should the error continue to occur.

## DAS4300

*Volser status request from client %1*

param %1     client name from the environment variable of the ACI initiating the command.

## Explanation

DAS/2 is receiving a **listv** command.

## User Activities

This is a notification message. No user activities are necessary.

## DAS4301

*Volser status request from client %1 completed %2*

param %1     client name from the environment variable of the ACI initiating the command.

param %2     *successful* or *with failure* (%3)

param %3     ACI error number

## DAS ACI Message

EOK

## Explanation

DAS/2 has terminated the **listv** command.

---

---

## User Activities

This is a notification message. No user activities are necessary if the command was successful. If the message contains “with failure”, an error has occurred, the cause of which is given in another log message.

## DAS4302

*No volser allocation.*

## DAS ACI Message

ENOVOLUME

## Explanation

DAS/2 is receiving a **listv** command.

The command is rejected.

## User Activities

- Check the volser range in the command.
- Check the volser ranges that are already reserved (**listv**) and compare the range with the command. The ranges must not overlap.
- Correct the command
- Repeat the command with the correct volser range
- Contact the ADIC/GRAU Storage Systems Customer Help Desk should the error continue to occur.

## DAS4400

*Request volser to drive from client %1*

param %1      client name from the environment variable of the ACI initiating the command.

## Explanation

DAS/2 is receiving a **getvolsertodrive** command.

## User Activities

This is a notification message. No user activities are necessary.

---

---

## DAS4401

*Request volser to drive from client %1 completed %2*

param %1     client name from the environment variable of  
                 the ACI initiating the command.

param %2     *successful* or *with failure* (%3)

param %3     ACI error number

### DAS ACI Message

EOK

### Explanation

DAS/2 has terminated the **getvolsertodrive** command.

### User Activities

This is a notification message. No user activities are necessary if the command was successful. If the message contains “with failure”, an error has occurred, the cause of which is given in another log message.

## DAS4402

*No volser-drive attachment.*

### DAS ACI Message

ENODRIVE

### Explanation

DAS/2 has terminated the **getvolsertodrive** command.

### User Activities

This is a notification message. No user activities are necessary if the command was successful. If the message contains “with failure”, an error has occurred, the cause of which is given in another log message.

---

---

## DAS ACI Messages

The following messages provide information for DAS ACI generated by the ACI on the client.

### ACI0001

*Invalid value assigned to d\_errno (%1).*

param %1     value in the *d\_errno* variable

#### Explanation

An ACI request has been canceled due to an error. The value given in the variable (*d\_errno*) is invalid.

#### User Activities

- Search for the cause of the error in the AMU log.
- Contact the ADIC/GRAU Storage Systems Customer Help Desk.

### ACI0002

*%1 not defined in the environment.*

param %1     environment variable which was not found.

#### Explanation

A search was made for the DAS\_SERVER and DAS\_CLIENT environment variables when the ACI components was initialized in order to determine the AMU's IP address and to obtain information on the client's name. One or more environment variables were not found. The command is not sent to the server.

#### User Activities

- Set the environment variables and repeat the command
- Contact the ADIC/GRAU Storage Systems Customer Help Desk should the error continue to occur.

---

---

## ACI0003

*%1 is an invalid hostname or IP address.*

param %1     Value of the DAS\_SERVER environment variable

### Explanation

The DAS\_SERVER environment variable was found when the ACI components were initialized. Evaluation of the variable produced an invalid IP address (incorrect syntax) or a host name which cannot be resolved into an IP address by the TCP/IP service (domain name server or local hosts file). The command is not sent to the server.

### User Activities

- Check the DAS\_SERVER environment variable.
- Test the resolution of the host name using the **ping** command on the host name.
- Repeat the command once you have corrected the environment variable or the host name resolution.
- Contact the ADIC/GRAU Storage Systems Customer Help Desk should the error continue to occur.

## ACI0004

*Function clnttcp\_create failed.*

### Explanation

An RPC error occurred in the *clnttcp\_create()* function while the ACI components were being initialized; the cause may be a fault:

- in the TCP/IP communication, or
- in the DAS/2 program.

The command is not sent to the server.

### User Activities

- Check the DAS\_SERVER environment variable.
- Use a **ping** command to test whether you can reach the server specified in the environment variable; use a **ping** command on the host name to test the host name resolution.

- 
- 
- Check whether the DAS/2 operation exists on the AMU PC and is operating fault-free. (DAS/2 window with the DAS/2 ready message).
  - Repeat the command once you have reestablished the communication or the DAS/2 program has been restarted.
  - Contact the ADIC/GRAU Storage Systems Customer Help Desk should the error continue to occur.

## ACI0005

*Function clnt\_call (rc = %1) failed.*

param %1      return value of the clnt\_call function

### Explanation

An RPC error occurred in the *clnt\_call()* function while the ACI components were being initialized.

The command is not sent to the server.

### User Activities

Contact the ADIC/GRAU Storage Systems Customer Help Desk.

## ACI0006

*RPC could not reply to NULLPROC.*

### Explanation

An RPC error occurred while the ACI components were being initialized. The error cannot be rectified by the ACI.

### User Activities

Contact the ADIC/GRAU Storage Systems Customer Help Desk.



---

---

## **ACI0007**

*RPC could not get arguments.*

### **Explanation**

An RPC error occurred in the *svc\_getargs()* during RPC communication.

The error cannot be rectified by the ACI.

### **User Activities**

Contact the ADIC/GRAU Storage Systems Customer Help Desk.

## **ACI0008**

*RPC could not reply to DAS.*

### **Explanation**

An RPC error occurred in the *svc\_sendreply()* during RPC communication.

The error cannot be rectified by the ACI.

### **User Activities**

Contact the ADIC/GRAU Storage Systems Customer Help Desk.

## **ACI0009**

*RPC could not free arguments.*

### **Explanation**

An RPC error occurred in the *svc\_freeargs()* during RPC communication.

The error cannot be rectified by the ACI.

### **User Activities**

Contact the ADIC/GRAU Storage Systems Customer Help Desk.

---

---

## ACI0010

*Function sysconf failed.*

### Explanation

An ACI error occurred in the *sysconf()* during command execution.

The error cannot be rectified by the ACI.

### User Activities

Contact the ADIC/GRAU Storage Systems Customer Help Desk.

## ACI0011

*Error in function select: %1.*

param %1     name of the function which caused the error

### Explanation

An internal ACI error occurred during command execution.

The error cannot be rectified by the ACI.

### User Activities

Contact the ADIC/GRAU Storage Systems Customer Help Desk.

## ACI0012

*Function svctcp\_create failed.*

### Explanation

An ACI error occurred in the *svctcp\_create()* during command execution.

The error cannot be rectified by the ACI.

### User Activities

Contact the ADIC/GRAU Storage Systems Customer Help Desk.

---

---

## **ACI0013**

*Failure obtaining RPC program number.*

### **Explanation**

An internal ACI error occurred during command execution. The error cannot be rectified by the ACI.

### **User Activities**

Contact the ADIC/GRAU Storage Systems Customer Help Desk.

## **ACI0014**

*Function `svc_register` failed.*

### **Explanation**

An internal ACI error occurred in the `svc_register()` during command execution. The error cannot be rectified by the ACI.

### **User Activities**

Contact the ADIC/GRAU Storage Systems Customer Help Desk.

## **ACI0015**

*RPC failed. DAS initial response is %1.*

param %1      return value from the DAS

### **Explanation**

An internal ACI error occurred during command execution. The error cannot be rectified by the ACI.

### **User Activities**

Contact the ADIC/GRAU Storage Systems Customer Help Desk.

---

---

## ACI0020

*%1 is not defined.*

param %1     syntax of parameter from the command is  
                 incorrect

### Explanation

A syntax error was detected by the ACI during command execution. The command is not executed.

### User Activities

- Correct the syntax in your application and repeat the command.
- Contact the ADIC/GRAU Storage Systems Customer Help Desk should the error continue to occur.

## ACI0021

*%1 %2 is longer than %3.*

param %1     type of variable which caused the error  
param %2     name of variable which caused the error  
param %3     maximum permitted length of variable  
                 (character string)

### Explanation

The number of characters in the specified variable is greater than the permitted maximum.

### User Activities

- Amend the definition of the maximum permitted length and repeat the command.
- Contact the ADIC/GRAU Storage Systems Customer Help Desk should the error continue to occur.

---

---

## ACI0022

*%1 %2 contains an invalid character*

param %1     parameter in the command  
param %2     name of the parameter in the command

### Explanation

Special characters which are not permitted for this parameter were discovered when the command was verified.

### User Activities

- Check the parameter for special characters and remove these.
- Repeat the command.
- Contact the ADIC/GRAU Storage Systems Customer Help Desk should the error continue to occur.

## ACI0023

*Invalid %1.*

param %1     invalid parameter

### Explanation

The command failed due to an invalid parameter.

### User Activities

- Check the parameter.
- Repeat the command.
- Contact the ADIC/GRAU Storage Systems Customer Help Desk should the error continue to occur.

---

---

## ACI0024

*Hostname %1 is not correct.*

param %1     host name in the command

### Explanation

Evaluation of the variable produced an invalid IP address (incorrect syntax) or a host name which cannot be resolved into an IP address by the TCP/IP service (domain name server or local hosts file). The command is not sent to the server.

### User Activities

- Test the resolution of the host name using the **ping** command on the host name.
- Repeat the command once you have corrected the host name resolution.
- Contact the ADIC/GRAU Storage Systems Customer Help Desk should the error continue to occur.

---

---

## Derrno Variable

The following variables are written to the *derrno* variable as a result of a command and can be read out by the application:

### 0 - EOK

*The request was successful.*

#### Explanation

The command has been completed without error; no further information available.

#### User Activities

No activities required.

### 1 - ERPC

*An RPC failure occurred.*

#### Explanation

A client could not send its request to the server or the server is not responding to the request.

#### User Activities

- Check
  - that the TCP/IP service portmapper has started on both the AMU and the client PC;
  - that the RPC service is functioning correctly. Start the **rpcinfo -p** command to view the status of the RPC service;
  - that the DAS\_SERVER environment variable contains the host name or the IP address of the AMU;
  - that the host name is correctly resolved into the IP address in the TCP/IP network. Test the communication by pinging the host name;
  - that the DAS/2 program is running on the AMU.

- 
- 
- Contact the ADIC/GRAU Storage Systems Customer Help Desk should the error continue to occur.

## 2 - EINVALID

*An ACI parameter is invalid.*

### Explanation

One or more parameter in the command is invalid. The command was rejected by the ACI.

### User Activities

- Compare the parameters in the command with the specification in the *dasadmin* online help program or in the ACI Interfacing Guide
- Correct the parameters and repeat the command.
- Contact the ADIC/GRAU Storage Systems Customer Help Desk should the error continue to occur.

## 3 - ENOVOLUME

*A volume of this type is not found.*

### Explanation

The volser specified in the command and its associated media type was not found in the AMU database or in the AML system at the relevant position.

### User Activities

- Check
  - the volser in the command;
  - the AMU database (that the volser is present only once and has the appropriate media type);
  - the AML system (that the volser is located at the slot specified in the AMU database).
- Correct the command/database or insert the missing volser.
- Contact the ADIC/GRAU Storage Systems Customer Help Desk should the error continue to occur.



---

---

## 4 - ENODRIVE

*The drive is not defined in the AML.*

### Explanation

The requested drive was not found in the AMS configuration. The command is not executed.

### User Activities

- Check
  - that the names in the command or its application are for the drive with the configured name in the AMS configuration (*Graphical Configuration - Drive Configuration - Description*); be aware that a maximum of 9 alphanumeric characters are permitted for the drive name.
- Contact the ADIC/GRAU Storage Systems Customer Help Desk should the error continue to occur.

## 5 - EDRVOCCUPIED

*The requested drive is currently in use.*

### Explanation

The requested drive is registered in the AMU database as still occupied, and the *no\_dismount* option has not been set. The command is not executed.

### User Activities

- Check
  - whether the **dismount** command has failed;
  - whether it is the application that does not unload the drive (altering to the *dismount* option to *no\_dismount* is necessary)
  - there is an error in the AMU database (check the drive).
- Contact the ADIC/GRAU Storage Systems Customer Help Desk should the error continue to occur.

---

---

## 6 - EPROBVOL

*The robot encountered a problem handling the volume.*

### Explanation

A command has failed due to a problem with the AML hardware. The AML system cannot solve the problem. The problem may be:

- a medium which has fall to the floor
- some mechanical resistance when loading the medium in the drive or in its storage place
- a damaged barcode or problems with the barcode-reading equipment
- a medium is in the gripper because the problem box in full

### User Activities

- Check the AMU log (AMU error message for this problem)
- Rectify the problem following the operating instructions in the AMU manuals and hardware documentation.
- Contact the ADIC/GRAU Storage Systems Customer Help Desk should the error continue to occur.

## 7 - EAMU

*An unexpected response code was received from the AMU.*

### Explanation

The AMU reacts to a command with an unexpected error message, or there is an internal fault in the AMU.

### User Activities

- Check the AMU log (AMU error message for this problem)
- Rectify the problem following the operating instructions in the AMU manuals and hardware documentation.
- Contact the ADIC/GRAU Storage Systems Customer Help Desk should the error continue to occur.

---

---

## 8 - EAMUCOMM

*DAS was unable to communicate with the AMU.*

### Explanation

DAS does not send acknowledgment of the command to the AMS.

### User Activities

- Check that the AMU operations are functioning correctly
- Restart the OS/2 PC
- Contact the ADIC/GRAU Storage Systems Customer Help Desk should the error continue to occur.

## 9 - EROBO

*The robotic system is not functioning.*

### Explanation

A command cannot be executed because the robotic controller status is offline. The cause of this may be a problem with the hardware or communication, or an offline command from a user.

### User Activities

- Try to bring the robotic controller back online using the **robstat** command. Check the AMU log for the corresponding AMS error message if this is unsuccessful
- Rectify the problem following the operating instructions in the AMU manuals and hardware documentation.
- Contact the ADIC/GRAU Storage Systems Customer Help Desk should the error continue to occur.

---

---

## 10 - EROBOTCOMM

*The AMU was unable to communicate with the robot.*

### Explanation

Communication between AMS and a component used to control the AML has broken down.

### User Activities

- Try the command a second time to see if the link reestablishes. Check the AMU log for the corresponding AMS error message if this is unsuccessful and restart the AML system.
- Rectify the problem following the operating instructions in the AMU manuals and hardware documentation.
- Contact the ADIC/GRAU Storage Systems Customer Help Desk should the error continue to occur.

## 11 - ENODAS

*DAS is not active.*

### Explanation

The DAS/2 program is not active

### User Activities

- Check that the DAS/2 operation is active. Restart the DAS/2.
- Contact the ADIC/GRAU Storage Systems Customer Help Desk should the error continue to occur.

---

---

## 12 - EDEVEMPTY

*The drive did not eject a volume.*

### Explanation

The robotic controller could not grip the medium at the drive. The command is not executed.

### User Activities

- Check that the drive has received a command to unload. Loading by the robotic controller may be necessary for your application and has to be defined in the AMS drive configuration.
- Check the drive. There may still be a medium in the drive.
- Check the timekeeping (if necessary, adjust the dismount manager parameters for the drive in the AMS configuration).
- Contact the ADIC/GRAU Storage Systems Customer Help Desk should the error continue to occur.

## 13 - ENOTREG

*The client is not registered with DAS.*

### Explanation

The command was received from a server for a client that has not been defined. The command is rejected.

### User Activities

- Check whether the client is using the correct environment variables and that they have also been set in the DAS configuration file.
- Change the configuration file or the environment variable for the client
- Restart the DAS program following changes to the configuration file.
- Contact the ADIC/GRAU Storage Systems Customer Help Desk should the error continue to occur.

---

---

## 14 - EBADHOST

*The hostname or IP address is not valid.*

### Explanation

DAS/2 has received a command with an invalid TCP/IP address or host name. The host name or the IP address is not defined in DAS (temporarily or in the *config* file) or the host name cannot be resolved by the TCP/IP configuration. The command is rejected.

### User Activities

- Check whether the TCP/IP address or host name is specified in the *config* file and whether DAS was restarted following the last amendment to the *config* file, or if the client has been temporarily configured using the **scap** command.
- Repeat the command when the configuration has been modified.
- Contact the ADIC/GRAU Storage Systems Customer Help Desk should the error continue to occur.

## 15 - ENOAREA

*The area name does not exist.*

### Explanation

DAS/2 has received a command for a logical range which is not defined as a logical range in the I/O unit in the AMS configuration, or has not been determined for the client in the DAS configuration. The command is rejected.

### User Activities

- Check the range name in the command (e.g. E01)
- Compare these names with those specified in the I/O unit configuration in the AMS; repeat the command when you have updated the configuration
- Check the DAS configuration file *config*
- Contact the ADIC/GRAU Storage Systems Customer Help Desk should the error continue to occur.

---

---

## 16 - ENOTAUTH

*The client is not authorized to make this request.*

### Explanation

DAS/2 has received a command for which the client is not authorized.

### User Activities

- Check the *config* file for this client:
  - the volser range
  - the drives
  - the access privileges (restricted or complete)
- Check whether DAS was restarted following the last amendment to the *config* file, or if the client has been temporarily configured using the **scap** command.
- Repeat the command when you have modified the configuration.
- Contact the ADIC/GRAU Storage Systems Customer Help Desk should the error continue to occur.

## 17 - EDYNFULL

*The archive does not have dynamic positions available.*

### Explanation

No more slots are available for new volsers to be inserted because:

- no slots of type *AMU Dynamic* exist in the AMU database
- the slot in the AMU Dynamic range are already full and reserved for temporarily ejected volsers
- the media in the I/O unit are of another media type

### User Activities

- Check the AMU database for free slots with the parameters:
  - Type: AMU Dynamic
  - Attributes: Empty
  - Volser: 0000000000000000

- 
- 
- Contact the ADIC/GRAU Storage Systems Customer Help Desk should the error continue to occur.

## 18 - EUPELSE

*The drive is currently assigned to another client.*

### Explanation

DAS/2 has received a command to change the access privileges for the drives, but the specified drive is presently occupied by another client. The command is rejected.

### User Activities

- Use **listd** to check which client is currently using the drive
- Initiate a dismount on the drive
- Agree with this user the times when a certain drive is used and by whom
- Vacate the drive whenever you have finished using it
- Contact the ADIC/GRAU Storage Systems Customer Help Desk should the error continue to occur.

## 19 - EBADCLIENT

*The client does not exist.*

### Explanation

DAS/2 has received a command from a client that is not configured in DAS or from a client with restricted access privileges. The command is rejected.

### User Activities

- Check whether the client name is specified in the *config* file using the same conventions (lowercase/uppercase) and whether DAS was restarted following the last amendment to the *config* file, or if the client has been temporarily configured using the **scap** command.
- Check the client's environment variables and the setting in the application which uses the ACI.
- Check the client's privileges in the configuration.
- Contact the ADIC/GRAU Storage Systems Customer Help Desk should the error continue to occur.



---

---

## 20 - EBADDYN

*The dynamic area does not exist.*

### Explanation

DAS/2 has received a command for a logical range which is not defined as a logical range in the I/O unit in the AMS configuration, or has not been determined for the client in the DAS configuration. The command is rejected.

### User Activities

- Check the range name in the command (e.g. E01)
- Compare these names with those specified in the I/O unit configuration in the AMS; repeat the command when you have updated the configuration
- Check the DAS configuration file *config*
- Contact the ADIC/GRAU Storage Systems Customer Help Desk should the error continue to occur.

## 21- ENOREQ

*A request with this number does not exist.*

### Explanation

A sequence number which is presently not in the DAS command queue was specified for the **cancel** command.

### User Activities

Check the outstanding commands using the **list** command and select the corresponding sequence number from it. Repeat the command with the correct sequence number

Contact the ADIC/GRAU Storage Systems Customer Help Desk should the error continue to occur.

---

---

## 22 - ERETRYL

*Retry attempts exceeded.*

### Explanation

There has been an attempt to repeat a command automatically, despite there being problems in the command's execution. The maximum number of iterations has now been reached and the command could not be successfully executed.

### User Activities

- Check the AMU log (AMU error message for this problem)
- Rectify the problem following the operating instructions in the AMU manuals and hardware documentation.
- Contact the ADIC/GRAU Storage Systems Customer Help Desk should the error continue to occur.

## 23 - ENOTMOUNTED

*The requested volser is not mounted.*

### Explanation

It has been determined for a **dismount** command that, according to the AMU database, there is no volser in the drive

### User Activities

- Check the command (volser)
- Check the volser with the entries in the AMU database and check the drive at its slot
- Also check the dismount manager setting.
- Contact the ADIC/GRAU Storage Systems Customer Help Desk should the error continue to occur.

---

---

## 24 - EINUSE

*The requested volser is in use.*

### Explanation

A command for a volser has been started although, according to the AMU database, this volser is mounted, ejected, and/or **inventory** command has been started although an inventory is already underway.

### User Activities

- Check the volser in the command.
- Wait until the volser is available once more or issue the appropriate command (the commands are only stored in the AMS command queue if the current database status permits the command.)
- Contact the ADIC/GRAU Storage Systems Customer Help Desk should the error continue to occur.

## 25 - ENOSPACE

*Not enough space available to add the requested range.*

### Explanation

DAS/2 has received a command to temporarily add a client to the DAS configuration. The command has been rejected because the maximum number of clients has been exceeded. The client can only be added by altering the configuration (*config* file). An additional reason may be that the slot is not specified in the I/O unit as *Foreign* and *Empty* when foreign-mount volsers were added

### User Activities

Modify your configuration

- Remove a client that may not be need, or is not need at present
- Obtain the licence for additional clients
- Delete unneeded clients from the *config* file and specify the new client in its place.
- Restart the client.
- Check the definition of the slot for the foreign-mount volser in the AMU database

- 
- 
- Contact the ADIC/GRAU Storage Systems Customer Help Desk should the error continue to occur.

## 26 - ENOTFOUND

*The range or object cannot be found.*

### Explanation

The command contains a parameter that was not found in the configuration or in the AMU database.

### User Activities

- Check the command.
- Compare the parameters with the values from the configuration or the AMU database.
- Contact the ADIC/GRAU Storage Systems Customer Help Desk should the error continue to occur.

## 27 - ECANCELLED

*The request was canceled.*

### Explanation

A command has been deleted from the command queue by **shutdown** or **cancel**.

### User Activities

You must restart if the command is still to be executed.

---

---

## 28 - EDASINT

*An internal DAS error occurred.*

### Explanation

A situation has arisen during command processing in the DAS program which cannot be rectified by the program.

### User Activities

- Save the associated AMS log. Terminate DAS using <Ctrl>+<c> and then restart DAS.
- Contact the ADIC/GRAU Storage Systems Customer Help Desk.

## 29 - EACIINT

*An internal ACI error occurred.*

### Explanation

A situation has arisen during command processing in the ACI which cannot be rectified by the program.

### User Activities

- Save the associated AMS log. Terminate DAS using <Ctrl>+<c> and then restart DAS.
- Contact the ADIC/GRAU Storage Systems Customer Help Desk.

---

---

## 30 - EMOREDATA

*More data available.*

### Explanation

Valid data was returned for the **qvolsrange** command. This has determined that the specified range contains a number larger than the entries specified in the count. You can query the remaining data using another command.

### User Activities

For further information about other volsers, start another command with the next volser specified. This process for collecting volser information can continue until *d\_errno* returns 0.

## 31 - ENOMATCH

*Command parameters do not match.*

### Explanation

While executing the command, DAS/2 has detected that parameters in the command are not correct, e.g. the slot (AMU database) does not match the media type in the command (environment variable).

### User Activities

- Check the command and the environment variable.
- Compare the specification with the AMS configuration (media type in the graphical configuration of the I/O unit).
- Contact the ADIC/GRAU Storage Systems Customer Help Desk should the error continue to occur.

---

---

## 32 - EOTHERPOOL

*Volser defined to another pool.*

### Explanation

When a request was made to add a volser to a scratch pool, it was detected that this volser already belongs to another scratch pool. The command is rejected.

### User Activities

- Check the pool name.
- Change the pool associated in the AMS if the volser is to change pools
- Contact the ADIC/GRAU Storage Systems Customer Help Desk should the error continue to occur.

## 33 - ECLEANING

*Drive is being cleaned.*

### Explanation

A command was started but this drive is presently being cleaned. The command is rejected.

### User Activities

- Wait until drive-cleaning has finished and then repeat the command.
- Contact the ADIC/GRAU Storage Systems Customer Help Desk should the error continue to occur.

---

---

## 34 - ETIMEOUT

*The ACI request timed out.*

### Explanation

The command was timed out without a response being sent from the DAS program.

### User Activities

- Check the status of the machine (**robstat**) and the AMU log for associated errors.
- Repeat the command.
- Contact the ADIC/GRAU Storage Systems Customer Help Desk should the error continue to occur.

## 35 - ESWITCHINPROG

*The AMU is not ready because AMU is starting a switch*

### Explanation

DAS has been informed by the AMS that the passive AMU is now active. No new commands will be accepted during this switching phase, but those already in the command queue are processed.

### User Activities

- Inform all affected users before using the switch command.
- Repeat the rejected command when the switching procedure is complete.
- Wait for up to two minutes (until the switching process has finished) and then repeat the command.
- Contact the ADIC/GRAU Storage Systems Customer Help Desk should the error continue to occur.



---

---

## 36 - ENOPOOL

*The pool name is not defined.*

### Explanation

DAS/2 is receiving an **insert** command for cleaning cartridges with a clean pool name that has not been defined. The command is rejected.

### User Activities

- Check the clean pool name in the command.
- Check the configured clean pool names in the AMS and compare the name with the name in the command
- Correct the configuration or the command
- Repeat the command with the correct clean pool name
- Contact the ADIC/GRAU Storage Systems Customer Help Desk should the error continue to occur.

## 37 - EAREAFULL

*The eject area is full.*

### Explanation

DAS/2 is receiving an **eject** command for cleaning cartridges for whose media type there is no slot or no free slot in the ejection range of the AMU database. The command remains in the command queue until a range is made available.

### User Activities

- Check the ejection range.
- Remove the cartridges occupying the ejection range in the I/O unit.
- Correct the configuration if the ejection range does not match the media type
- Repeat the command on the correct ejection range
- Contact the ADIC/GRAU Storage Systems Customer Help Desk should the error continue to occur.

---

---

## 38 - EHICAPINUSE

*Robot is not ready because of a HICAP request*

### Explanation

The robotic controller in the AML/J system is switched off while the door (HICAP) is open. DAS holds all outstanding commands in the command queue but does not accept any new commands into the DAS command queue.

### User Activities

- Organize your operation so that no commands are sent to the AML/J while the I/O unit (HICAP) is being configured.
- Inform all other connected subscribers before opening the HICAP.

## 39 - ENODOUBLESIDE

*The volser has no two sides*

### Explanation

A command was issued that requires a double sided volser, however the volser used was not double sided.

### User Activities

Verify the volser and correct it if necessary

## 40- EEXUP

*The drive is EXUP for another client.*

### Explanation

The drive is currently allocated to another client.

### User Activities

The client that has allocated the drive must deallocate the drive, otherwise the DAS\_SUPERVISOR client should be used to deallocate the drive.

---

---

## ■ ■ 41- EPROBDEV

*The robot has a problem with handling the device.*

### ■ ■ Explanation

The command could not be executed because the robot has a problem with the device handling

### ■ ■ User Activities

Check the AMU log for a more detailed error message. For information about the error, refer to the *AMU Administration Guide*.

## ■ ■ 42- ECOORDINATE

*One or more coordinates are wrong.*

### ■ ■ Explanation

DAS sent a command to the AMU with an illegal coordinate.

### ■ ■ User Activities

Check the command description.

## ■ ■ 43- EAREAEMPTY

*Area that is to be ejected is already empty.*

### ■ ■ Explanation

An INSERT command was issued but the I/E area is empty

### ■ ■ User Activities

Verify that the volser has not already been inserted.

## ■ ■ 44- EBARCODE

*Barcode read error.*

---

---

## Explanation

The barcode could not be read by the barcode reader on the robotic controller during a command. The command is not executed.

## User Activities

## 45 - EUPDOWN

*Client tried to allocate volers that are already allocated.*

## Explanation

## User Activities

## 46 - ENOTSUPPHCMD

*Host command not supported*

## Explanation

DAS sent a command to the AMU that is not supported by the AMU.

## User Activities

The AMU has a command exclusion feature that can be used to configured which DAS commands are supported. The command that was sent to the AMU is configured as a not supported host command. Refer to the *AMU Administration Guide* if this needs to be changed.

## 47 - EDATABASE

There was an error during reading and writing of the database.

## Explanation

The AMU was unable to read or write the database

---

---

## User Activities

Check the AMU log for a more detailed message. Also check the AMU error message. For further information refer to the *AMU Administration Guide*.

## 48 - ENOROBOT

*The robot is not configured.*

### Explanation

The AMU could not execute the command because the wrong robot, or no robot is configured

### User Activities

Check the AMU configuration

## 49 - EINVALDEV

*The device is invalid.*

### Explanation

A command was sent with an illegal device.

### User Activities

Check the device parameter and correct it if necessary.

## 50 - NO\_ECOCODES

*Number of error codes.*

### Explanation

### User Activities

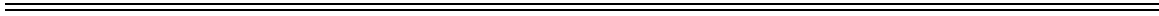

# 7

## Utilities

|                                  |     |
|----------------------------------|-----|
| Overview .....                   | 7-3 |
| RPC Test (TCP/IP Function) ..... | 7-3 |
| DAS Wait Program .....           | 7-3 |
| Startup.smp .....                | 7-4 |
| DB/2 query tools .....           | 7-4 |
| CNT2ZERO.CMD .....               | 7-4 |
| SHOWPOOL.CMD .....               | 7-5 |
| SHOWSCRATCH.CMD .....            | 7-5 |
| SHOWVOLSER.CMD .....             | 7-5 |

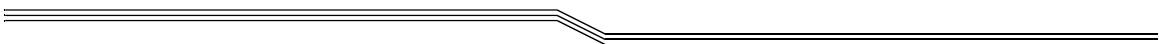





---

---

## Overview

The `\das\tools` directory contains files and programs intended for help when working with DAS.



The functions in the `\das\tools` directory are add-ins and are not a constituent part of the software supplied, therefore are not guaranteed.

## RPC Test (TCP/IP Function)

In the event of a problem with communication between ACI and DAS, the RPC service can be tested with this function. The location of the problem can be determined directly from the test response if, before the test is run, the file `rpc` is copied to the `\tcpip\etc` (TCP/IP 2.0) or `\mptn\etc` (TCP/IP 3.0) directory. See Figure 7-1.

DAS is registered with the number 536875008 or 0x20001000. The ACI is registered with the number 1073747824 or 0x40000000. If more than one ACI is registered, the number will increase by one.

```
rpcinfo -p
```

Figure 7-1 Example of the Rpcinfo Command

See Figure 7-2 for an example of a response to the `rpcinfo` command.

```
program vers proto port
536875008 1 tcp 1024 GRAU_DAS2_13
```

Figure 7-2 Example of a Response to the Rpcinfo Command

## DAS Wait Program

The system must wait while the AMU programs (AMS, DAS) initialize, so that communications can be established correctly. The `os2sleep` program is called from the `Startup.cmd` file for this purpose. See Figure 7-3.

```
os2sleep time
```

**Figure 7-3** Example of the Os2sleep Command

See Table 5-52 for an explanation of the parameter for the **os2sleep** command.

**Table 5-52** Parameter for the Os2sleep Command

| Parameter | Explanation                                            |
|-----------|--------------------------------------------------------|
| time      | Delay in seconds before batch processing is continued. |

## Startup.smp

*Startup.smp* is a sample file for launching the AMU programs automatically. An explanation of this file may be found in the AMU Reference Manual.

## DB/2 query tools

The *tools\db2* and *toolsdbm* directories contain some small utilities for querying the DB/2 database.



**Instructions on how to use these programs may be found in a “README” file in the DB2 directory. Use the programs in the *tools\db2* directory for the Database Manager version and those in the *tools\dbm* directory for older versions. (The version can be queried under OS/2 with the *syslevel* command)**

The following OS/2 command files are provided for querying and modifying the database.

- CNT2ZERO.CMD
- SHOWPOOL.CMD
- SHOWSCRATCH.CMD
- SHOWVOLSER.CMD

### CNT2ZERO.CMD

The **CNT2ZERO.CMD** command sets the counter for use count and crash count (not used) to 0 for all volsers in the AML.

---

---

## **SHOWPOOL.CMD**

The **SHOWPOOL.CMD** command displays the scratch pool information.

## **SHOWSCRATCH.CMD**

The **SHOWSCRATCH.CMD** command displays the scratch volser for a specified pool. Figure 7-4.

```
showscratch pool-name
```

**Figure 7-4** Example of the Showscratch Command

## **SHOWVOLSER.CMD**

**SHOWVOLSER.CMD** displays the “scratch” status of a volser (scratch or non-scratch media). See Figure 7-5.

```
showvolser pool-name
```

**Figure 7-5** Example of the Showvolser Command



# 8

## Communication Applications

|                                                   |      |
|---------------------------------------------------|------|
| Overview .....                                    | 8-3  |
| ADSM VirOp .....                                  | 8-3  |
| Installation .....                                | 8-3  |
| Setup .....                                       | 8-5  |
| Install Option .....                              | 8-5  |
| Configure Drives .....                            | 8-5  |
| Configure Libraries .....                         | 8-6  |
| Update Drive Config .....                         | 8-7  |
| Update Library Config .....                       | 8-7  |
| ADSM Configuration .....                          | 8-7  |
| Scratch Handling .....                            | 8-8  |
| Required DAS Configuration .....                  | 8-8  |
| DRM Support .....                                 | 8-9  |
| Shell Scripts .....                               | 8-9  |
| Label Script .....                                | 8-12 |
| Using EMM commands without ADSM .....             | 8-12 |
| ARCserve VirOp for Novell .....                   | 8-14 |
| Concept .....                                     | 8-14 |
| Schematic Structure of the Work Environment ..... | 8-14 |
| Backup .....                                      | 8-15 |
| Restore .....                                     | 8-16 |
| Design .....                                      | 8-16 |
| Object Diagram .....                              | 8-16 |
| ArcVirOp .....                                    | 8-18 |
| ConfigMgr .....                                   | 8-18 |
| MediaListMgr .....                                | 8-18 |
| DriveListMgr .....                                | 8-18 |
| JobListMgr .....                                  | 8-18 |
| ARCObserver .....                                 | 8-19 |
| DASAdaptor .....                                  | 8-19 |
| Ctrace .....                                      | 8-19 |
| Installation .....                                | 8-19 |



---

---

|                                                                           |      |
|---------------------------------------------------------------------------|------|
| Installation Files .....                                                  | 8-19 |
| Installation Procedure .....                                              | 8-20 |
| Configuration .....                                                       | 8-20 |
| Configuration Parameters .....                                            | 8-20 |
| Example File ArcVirOp.cfg .....                                           | 8-23 |
| Example File Medialist.txt .....                                          | 8-25 |
| Example File Drivelist.txt .....                                          | 8-25 |
| Example File Config of the DAServer on the AMU Controller (OS/2 Computer) |      |
| 8-25                                                                      |      |
| Start-up .....                                                            | 8-26 |
| Sequence of Operations .....                                              | 8-26 |
| Error, Warnings and Information .....                                     | 8-26 |
| Message Construction .....                                                | 8-26 |
| Messages .....                                                            | 8-27 |
| NETWORKER NT .....                                                        | 8-33 |
| Installation .....                                                        | 8-33 |
| Configuration .....                                                       | 8-33 |

---

---

## Overview

This section covers communication application. The following applications are discussed:

- ADSM VirOp software
- Arvserve VirOp software
- Networker NT

## ADSM VirOp

This section describes the ADSM VirOp software.

## Installation

The requirements for installing and executing the VirOp software are as follows:

- An ADIC AML library
- ADSM version 2
- a supported UNIX operating system (AIX, Solaris or HP/UX)
- ADIC DAS software.

The following platform dependent software releases are required:

**Table 8-1** Software Release to Platform Requirements

| Software | Version                                |
|----------|----------------------------------------|
| AIX      | AIX 4.14 or higher                     |
| SOLARIS  | Solaris 2.51 or higher                 |
| ADSM     | 2 with PTF level 15, or higher version |
| DAS      | 1.30C7 or higher                       |
| AMU      | 2.40 or higher                         |

The distribution files for the VirOp software are contained within a tar archive file. The tar file consists of a *Readme* text file, the VirOp executable, a setup script, and a utils directory of scripts. Procedures are listed to extract the file on either a UNIX machine or a PC.

---

---

To extract these files from a UNIX machine, proceed as follows:

- Step 1** Place the diskette in the UNIX machine.
- Step 2** If the UNIX machine `/usr/local/aci` directory exist, change to the directory.

— or —

If the directory does not exist, create the `/usr/local/aci` directory and change to the directory.

- Step 3** Use the tar extract command `tar -xvf /dev/...` where `/dev/...` is the file name where the diskette is mounted.

To extract these files from a PC, proceed as follows:

- Step 1** Place the diskette in the PC.
- Step 2** Copy the file to the desired directory.
- Step 3** Change to the directory.
- Step 4** On the UNIX machine:
  - a.** if the `/usr/local/aci` directory exist, change to the directory.

— or —

if the `/usr/local/aci` directory does not exist, create the directory and change to the directory.

- Step 5** On the PC, use the FTP command to put the tar file on the UNIX machine at the `/usr/local/aci` directory.
- Step 6** On the UNIX machine, use the tar extract command `tar -xvf tarfile`.

Run the setup script to step through the stages of installation and configuration of the VirOp software.

If any problems are experienced which are not resolved, contact ATAC.



---

---

## Setup

The setup script manages both the installation and configuration of the VirOp product. The primary options of the setup are the Install, Configure Drives and Configure Libraries. The options may be chosen in any order.

Setup uses the EDITOR environment variable to choose a comfortable editor. If this variable is not set, a prompt is provided for the editor name. To avoid this prompt, ensure that the EDITOR variable is set to a comfortable editor.

Example            `export EDITOR=vi`

The script creates files in the `/usr/local/aci` directory structure. This normally requires root privileges, therefore, verify that root privileges are available prior to running setup.

## Install Option

The install option simply moves the VirOp executable to the `/usr/local/bin` directory.

## Configure Drives

Normally, with ADSM, the **Define Drive** admin command is used to associate a drive name with a special file e.g., DLT3 to `/dev/mt/3`.

When the library is defined as external, this no longer holds true. After ADIC library is defined as External to ADSM, ADSM only knows the drives inside the library by their special file name. When ADSM wants to mount a volume, it requests that the mount be on any available drive. The VirOp product is task with selecting a drive and responding with the respective special file name.

The VirOp product acts as a client to the ADIC DAS product to identify drives with DAS. This requires the configuration option to map drive names to special file names. This option steps through mapping setup. The descriptive drive name in the AMU should be used as the drive name.

Any mistakes entering the drive names can be corrected by editing the prepared configuration file. When complete, the mapping is saved in the `/usr/local/aci/VirOp_drives` configuration file.

---

---

## Drive Naming

If the library is used by ADSM only, the naming convention is arbitrary. When the 1 - 9 characters and alphanumeric names are selected, setting these names in the AMU (the ADIC AML controller) is required.

## Adding Drives

To add drives, run this option again. The option appends the new drives to the existing drives in the configuration file.

## Ensure that All Drives are Defined

Ensure that all of the drives that ADSM could possibly use are in this mapping. If a drive is missing, any mount on the drive results in a syslog message. The message indicates that the VirOp product was unable to map the drive to a special file name. In such a case, the VirOp product cannot take the drive off-line. This leaves the volume in the drive and removes it from the available pool of drives.

## Drive Availability

Drives are made available to ADSM by allocating them to the External library DAS client. See *Configure Libraries*. This is done by using the DAS `dasadmin allocd` command. With the VirOp product, the mount requests from ADSM are not drive specific. The VirOp product relies on the DAS software to select an available drive for the client. A drive is only available to a client if the physical requirements of the volume are met and it is allocated to the client. Therefore, allocate the drives that ADSM will access.

## Configure Libraries

Conceptually, an ADSM external library is equivalent to a DAS client. Each external library defined to ADSM must have a DAS server and DAS client name associated with it.

Depending on the configuration of a DAS client, this allows an external library definition to be a partition of a library or a whole library. To support ADSM V3, a new parameter is required when configuring the library. The library eject area must be supplied.

This option allows mapping of the external library name to the DAS server name, DAS client names and library eject area. When mapping is completed, the mapping is saved in the `/usr/local/aci/VirOp_libs` configuration file.

---

---

## Defaulting External Libraries to DAS Clients

As a default option, the configuration file does not have to exist or it can have some of the external libraries defined. To completely default your library mapping, do not use this option. Otherwise, use the edit session and empty the configuration file contents. For those External libraries not in the configuration file, the VirOp product takes the external library name and use it as both the DAS server and DAS client name. For this default configuration to work, the TCP host name of the OS/2 PC running the DAS and AMU and the ADSM client must have the same name as the external library.

## Multiple ADSM Servers

When two or more ADSM servers are running on the same host, the same library configuration file is read by the VirOp product. It is possible to run this arrangement in either of two ways. Either define the AML as one External library to both ADSM servers or define the AML as one (or more) External libraries for each server on the host. Running as one External library allows a single pool of drives to be made available to all ADSM servers. Defining different External libraries means there must be separate pools of drives for each External library.

## Update Drive Config

This option starts an edit session with the `/usr/local/aci/VirOp_drives` drive configuration file.

## Update Library Config

This option starts an edit session with the `/usr/local/aci/VirOp_libs` library configuration file.

## Help

This option displays the *Readme* file.

## ADSM Configuration

ADSM version 2 contains a new library type; EXTERNAL. The VirOp program uses this type to integrate ADSM with the ADIC libraries.

To define a library as External, enter an ADSM client session with either system or unrestricted storage privilege. For each External library to define, use the following template:

---

---

Define Library *external library name* EXTERNAL  
LIBType=EXTERNAL

EXTERNALManger=/usr/local/bin/virop

For a defined external library, the **define drive** command can not be used to define a drive. ADSM knows the drives by their special file name. The mapping is specified in the file *VirOp\_drives* that is responsible for using the correct AMU drive name.

To make volumes available for ADSM, use the **define volume** command or the *gcheckin* script of the VirOp program. Ensure that the volumes are labeled. Refer to *Label Script* on page 8-12.

## Scratch Handling

Scratch processing is straightforward for the VirOp software. ADSM provides the scratch management and VirOp software satisfies the requests to give and return scratch volumes.

When ADSM requires a new volume for a storage pool, it requests a mount of a scratch volume. When mounted, the volume is marked as non-scratch to the AMU database and ADSM assigns the volume to the storage pool. Once all data on a volume has expired, ADSM requests that VirOp software released the volume back into the scratch pool.

The default scratch pool is used to satisfy all ADSM scratch requests. The label script, refer to *Label Script* on page 8-12, can be used with the [-s] option. This option requests that, after the ADSM label have been written to the volume, it is added back to the default scratch pool.

It is not essential to use scratch volumes with ADSM. It is possible to define volumes to each storage pool and ADSM does not request any scratch volumes while space is available.

There are three methods to define volumes to a scratch pool:

- Use the *dasadmin* commands.
- Use the *label* script with the [-s] option. Refer to *Label Script* on page 8-12.
- Use the *gcheckin* script with the [-s] option. Refer to *Gcheckin Script* on page 8-10.

## Required DAS Configuration

There are three steps to configuring the DAS product. The following section outlines the steps.

---

---

Follow these steps:

- Step 1** Configure a client statement for the ADSM client in the DAS config files.
- Step 2** Use `option=(no_avc,dismount)` for the option.
- Step 3** Use `scratchpools=((ALL))` for the scratchpool.

## DRM Support

VirOp software supports DRM with shell scripts. The shell scripts perform operations for moving DRM managed volumes in and out of the ADIC library.

### Shell Scripts

The following sections describe the *drmsetup*, *gcheckin*, *gcheckout*, *geject* scripts, and *ginsert* scripts.

#### **Drmsetup Script**

The *drmsetup* script creates the environment necessary for the other scripts in the DRM support. The script prompts the user for the following parameter values.

|                  |                                                                   |
|------------------|-------------------------------------------------------------------|
| Example          | drmsetup                                                          |
| <b>Parameter</b> | <b>Value</b>                                                      |
| ADSM Client      | Indicates the ADSM administrative client name for the DRM scripts |
| Password         | Indicates the password of this client                             |
| ADSM Client Path | Indicates the path to dsmadm                                      |
| Media            | Indicates the default media type that the DRM scripts use         |
| Eject area       | Indicates the default eject area that the DRM scripts use         |
| Insert area      | Indicates the default insert area that the DRM scripts use        |
| Storage pool     | Indicates the default storage pool that the DRM scripts use       |
| Scratch pool     | Indicates the default scratch pool that the DRM scripts use       |

---



---

|            |                                                                                   |
|------------|-----------------------------------------------------------------------------------|
| DAS Server | Indicates the DAS server of the external library                                  |
| DAS Client | Indicates the DAS client of the external library                                  |
| Dasadmin   | Indicates the directory path location of the DAS <b>dasadmin</b> utility commands |

Once the appropriate values are set for these parameters, allow the setup script to append them to the user's *.profile* or *.cshrc* file in the user's home directory. If the Apply option is chosen, the following scripts with the proper variable are generated by *drsetup* in the *utils* directory.

### Gcheckin Script

The *gcheckin* script is the ADIC version of the ADSM **checkin** command. To check in volumes, place those volumes in an insert area and execute the *gcheckin* script. If the parameters are not supplied on the command line, the script prompts the user for the following parameter values.

Example            `gcheckin [-i insert area] [-p storage pool] [-s]`

| Parameter | Value                                                                                               |
|-----------|-----------------------------------------------------------------------------------------------------|
| -i        | Indicates the insert area is not the default insert area established by the <i>drmsetup</i> script. |
| -p        | Indicates that the volumes are added to the storage pool                                            |
| -s        | Indicates that the volumes are added as scratch                                                     |

Once inserted, the volumes will be added to the storage pool and made available.

### Gcheckout Script

The *gcheckout* script is the ADIC version of the ADSM **checkout** command. If the parameters are not supplied on the command line, the script prompts the user for the following parameter values.

Example            `gcheckout [-v volser] [-e eject area] [-s ADSM state] [-r | -n]`

| Parameter | Value                       |
|-----------|-----------------------------|
| -v        | Indicates the volume volser |

---



---

|         |                                                                                                                                                              |
|---------|--------------------------------------------------------------------------------------------------------------------------------------------------------------|
| -e      | Indicates the eject area                                                                                                                                     |
| -s      | Indicates the ADSM state: unavailable, offsite, destroyed                                                                                                    |
| -r   -n | [ -r ] indicates that the volume should be removed from the library (the default condition)<br>[ -n ] indicates that the volume should remain in the library |

The *gcheckout* script makes a volume unavailable to ADSM.

### Geject Script

The *geject* script ejects volumes from the library. If the parameters are not supplied on the command line, the script prompts the user for the following parameter values.

Example            `geject [-e eject area] [-f input file]`

| Parameter | Value |
|-----------|-------|
|-----------|-------|

|    |                                                                                |
|----|--------------------------------------------------------------------------------|
| -e | Indicates the eject area                                                       |
| -f | Indicates that the list of volumes to eject are contained in <i>input file</i> |

The script will read the input file list for a list of volumes, otherwise it will interactively ask for the volumes to eject. Additionally, an eject area can be specified or the default area will be used.

### Ginsert Script

The *ginsert* script aids in the insertion of volumes. If the parameters are not supplied on the command line, the script prompts the user for the following parameter values.

Example            `ginsert [-i insert area] [-f input file]`

| Parameter | Value |
|-----------|-------|
|-----------|-------|

|    |                                                                                |
|----|--------------------------------------------------------------------------------|
| -i | Indicates the insert area                                                      |
| -f | Indicates that the list of volumes to eject are contained in <i>input file</i> |

The script scans the input file and prints the volumes to be inserted.

---

---

## Label Script

The *label* script automates the mounting, labeling (dsmlable is the ADSM label program) and dismounting a range of volumes. Ensure that the DAS environment variables in the *label* script are set correctly. If not, change the variable in the script to the appropriate value.

Example            `label start-number stop-number label-prefix  
device-name drivename [-s]`

| Parameter      | Value                                                                                                                                              |
|----------------|----------------------------------------------------------------------------------------------------------------------------------------------------|
| start-number   | a numeric range which when used with the stop-number parameter creates a range of volumes to be labeled                                            |
| stop number    | must be greater than the start-number parameter value                                                                                              |
| label-prefix   | a prefix for all volumes in the range                                                                                                              |
| device-name    | the file name of the drive where the volume should be placed and the label should be written                                                       |
| drivename [-s] | the DAS name for the same drive<br>-s indicates that after the volume is labeled, it is made scratch in the default scratch pool of its media type |

Example:            `Label 1 35 ADS /dev/mt/0 DLT0`

The example runs dsmlabel against volumes ADS001 to ADS035 on drive DLT0

The command runs the labeling against one drive. If more drives are available, run multiple copies of the *label* script using a different volume range on a different drive.

If a problem occurs during labeling, the name of the last labeled volume is kept in the file *lastlabeled\_drive-name* in the current directory. Once the problem is remedied, rerun the *label* script started from volume named in the *lastlabeled\_drive-name* file.

### Note

The command ensures a six character volume label by padding the length with the 0 character.

## Using EMM commands without ADSM

A method exists to test the EMM commands without running ADSM. Follow the steps to test the EMM commands without ADSM:

**Step 1**    Start the VirOp software by entering the **virop** command in the install directory.



---

---

 **Note**

Use the *ADSM Administrative Guide* to find the proper syntax for the EMM commands

**Step 2** Issue the EMM **INITIALIZE** command to initialize the library.

**Step 3** Enter the desire EMM command.

---

---

## ARCSERVE VirOp for Novell

This section describes the ARCSERVE VirOp software.

To run Arcserve Novell together with the VirOp a patch including two DLLs is required. This patch can be obtained by ADIC.

### Concept

The Arcserve Virtual Operator (ArcVirOp) serves as a link between ARCserve 6.x (German/English) under Novell and DAS. The task of ArcVirOp is to convert ARCserve backup and restore commands into corresponding DAS/AMU commands and dispatch them.

For this task, ArcVirOp utilizes several files (namely, *ARCH\$SRV.log*, *ArcVirOp.cfg*, *Drivepool.txt*, *Joblist.txt*, and *Medialist.txt*), and an ACI interface to the DAS/AMU.

The file *ARCH\$SRV.log* is an output file of ARCserve. ARCserve writes all required backup and restore commands in this file. The output is written in English or German and has a uniform structure. This structure enables ArcVirOp to recognize and evaluate backup and restore commands and convert them into corresponding ACI calls to the DAS/AMU.

A configuration file provides text patterns necessary for ArcVirOp to correctly interpret ARCserve outputs. The user can use this file (*ArcVirOp.cfg*) to exactly specify the text patterns that the program shall respond to and the location of important information required for the output conversion. These are drive and media designations and serial numbers. When ArcVirOp reads a new ARCserve output and the text does not correspond to one of the configured text patterns, the text is skipped.

ArcVirOp generates the necessary ACI calls in text form and transfers them to the DAS/AMU via the ACI interface. The ACI interface is made available to the ArcVirOp in form of a *DLL*.

### Schematic Structure of the Work Environment

Refer to Figure 8-1 on page 8-15 for the schematic structure of the work environment.

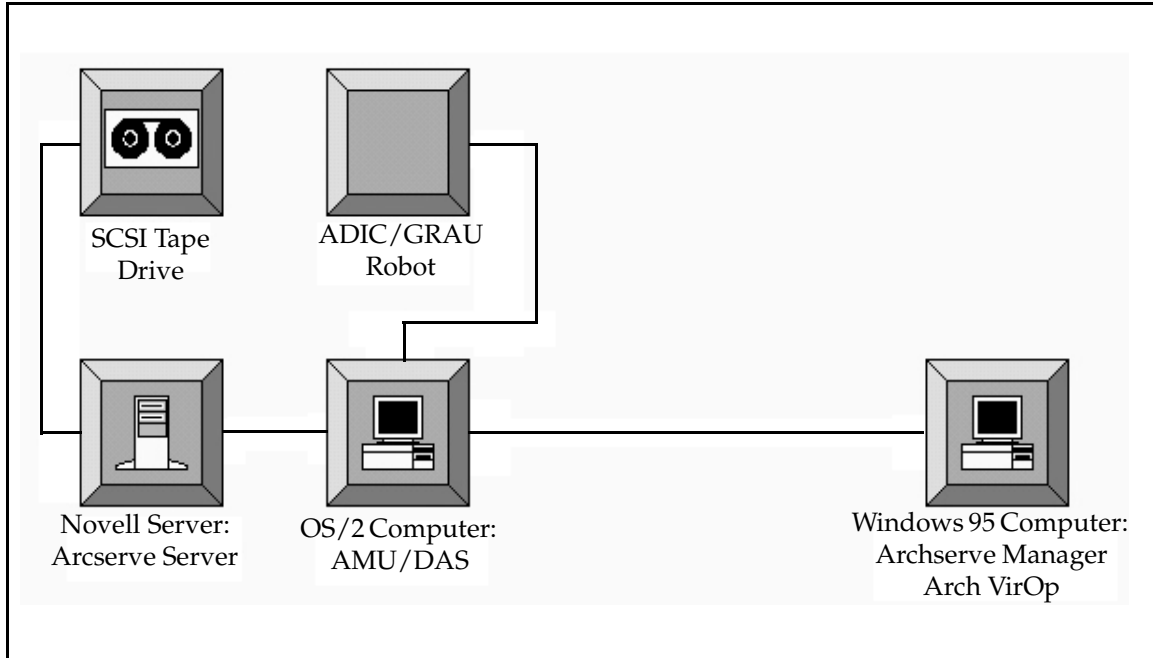

**Figure 8-1** Schematic Structure of the Work Environment

## Backup

When ArcVirOp recognizes a backup command, it determines the name of the device group (*DRIVE*) required for the ACI backup command from the text. In addition, ArcVirOp determines the serial number of the media following the **BACKUP** command. The required ACI command is generated using this data and transferred to the DAS/AMU via the ACI interface.

For a successful backup select the **Global Backup Options** menu. Once the menu appears, select the **Settings Menu**. From the **Settings** menu, select the **Eject Volume** option.

For a successful backup on several tapes, select the **Global Backup Option** menu. Once the menu appears, select **None** for the **Test Method** field. Otherwise, Arcserve does not eject tapes in the drive, and automatic operation cannot continue.

---

---

## Restore

When ArcVirOp recognizes a **RESTORE** command, it determines the device group and the volume serial number from the read text string. The required ACI command is generated using this data and transferred to the DAS/AMU via the ACI interface.

## Design

ArcVirOp is a WIN32 console application.

## Object Diagram

The Virtual Operator has been developed and implemented in the object-oriented language C++, using the development environment Visual C++ 5.0. All Virtual Operator objects involved are explained using the following OMT diagram. Refer to Figure 8-2 on page 8-17.

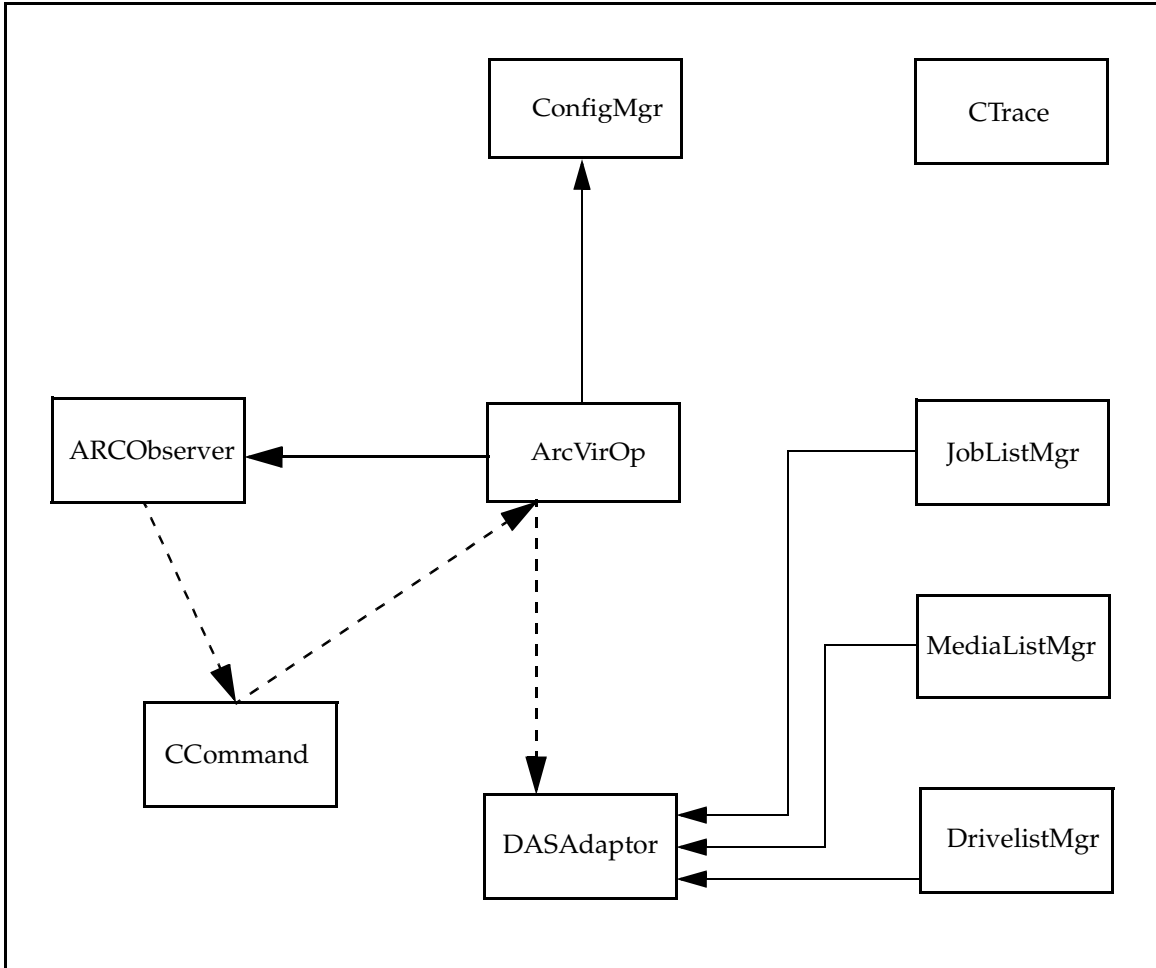

**Figure 8-2** ArcVirOp Objects

The descriptions of the individual classes in the next sections emphasize the interaction between individual objects. The specific methods are essentially brief and self-explanatory and are not described in detail. However, the most important methods for the functional cohesion are listed in the sections about the classes and described briefly. For the design development, particular attention is given to the encapsulation of independent tasks in individual classes. Therefore, specifics about the structure of ACI calls and configuration files could be hidden from the actual process classes.

---

---

## ArcVirOp

The class ArcVirOp is the core of the application. Only one object exists in this class. When instantiating this object, on the other hand, exactly one object is created in the class ConfigMgr, ARCObserver, and DASAdaptor. These objects are used in encapsulating specific tasks and invoked by ArcVirOp when required.

After starting ArcVirOp, the method `recvCmd()` of the object ARCObserver is perpetually invoked. When this method recognizes a new incoming command, it returns a corresponding newly created CCommand object. Next, the method `executeCommand()` of the object DASAdaptor is invoked. There, the new command is evaluated and the corresponding action performed.

## ConfigMgr

The class ConfigMgr is used for managing all of the application configuration data. The entire information in the configuration file is retrieved and stored in this object. All other program objects can retrieve the required information via the access procedures of the object ConfigMgr later during the program flow.

## MediaListMgr

The object MediaListMgr is responsible for the correct processing of the file Medialist. DASAdaptor creates an object in this class to read-in the file and for further managing. As required, DASAdaptor requests the next empty medium to be used via the method `getNextMedia()`. The object MediaListMgr persistently remembers this and, accordingly, writes the file Medialist constantly to the hard disk.

## DriveListMgr

The object DriveListMgr manages the *Drivepool.txt* file. When a backup or restore instruction is recognized, the *Drivepool.txt* file is opened and the allocation of the device group drives is checked.

## JobListMgr

The object JobListMgr manages current jobs. For it, the job number and the drive on which the job is executed is written to the *Joblist.txt* file. After the job execution, the entry is deleted from *Joblist.txt*. This enables DASAdaptor to dispatch specific dismount commands to the AMU.

---

---

## ARCObserver

The object in this class searches in the Arcserve output file *ARCH\$SRV.log* for new commands. The method `recvCmd()` searches in the newly written text for valid commands according to the syntax described in the configuration file. If the method finds a new command, a corresponding `CCommand` object is generated and returned to the caller.

## DASAdaptor

The object `DASAdaptor` encapsulates ACI calls from the remaining program. For every newly generated command, `ArcVirOpServer` calls the method `executeCommand()` with the newly generated `CCommand` object. In this method, the `CCommand` object is evaluated, and the corresponding ACI call is executed.

## Ctrac

The object `Ctrace` manages the log files and the corresponding entries. A current log file, *ArcVirOp.log*, and a log file from the previous day, *ArcVirOp.old*, is kept. Every night at 1:00 a.m., a new log file is created, and the log file that was current until that time is renamed into *ArcVirOp.old*, overwriting the existing valid *ArcVirOp.old* file.

## Installation

The installation diskette contains all files required for a correct installation. In addition, the diskette also contains several DLLs that are necessary for the `ArcVirOp` operation. Some of these DLLs may already be located on the target computer (e.g., in the `.. \WINDOWS` directory). We recommend copying the DLLs on the installation diskette into the target directory of `ArcVirOp` to ensure proper operation of the `ArcVirOp`. If the required DLLs are located in one of the system paths, `ArcVirOp` operation is also possible.

## Installation Files

The installation diskette contains the following files:

|                      |                                                                   |
|----------------------|-------------------------------------------------------------------|
| <i>ArcVirOp.exe</i>  | The program "Arcserve Virtual Operator"                           |
| <i>ArcVirOp.cfg</i>  | <code>ArcVirOp</code> configuration file (customization required) |
| <i>Medialist.txt</i> | Example of a media list file (customization required)             |

---



---

|                      |                         |
|----------------------|-------------------------|
| <i>Drivepool.txt</i> | Example of a drive list |
| <i>Joblist.txt</i>   | Example of a job list   |
| <i>mfc42.dll</i>     | System DLL              |
| <i>Msvcr7.dll</i>    | System DLL              |
| <i>Msvcp50.dll</i>   | System DLL              |
| <i>Rcmd32.dll</i>    | System DLL              |
| <i>ACI.dll</i>       | Program DLL             |

## Installation Procedure

Create the `x:\ArcVirOp` target directory for ArcVirOp.

Copy all files on the installation diskette into this directory (see comment above for DLL).

Copy the *ACI.CMD* file into the `C:\OS2` directory of the AMU PC.

Customize the configuration file.

Customize *Medialist.txt*.

Customize *Drivepool.txt*.

No additional installation steps are necessary.

In order to automatically start ArcVirOp during system start, create a shortcut for *ArcVirOp.exe* in the Windows Startup folder.

## Configuration

ArcVirOp is configured completely via the *ArcVirOp.cfg*, *Medialist.txt*, and *Drivepool.txt* files. These files can be edited with any editor.

## Configuration Parameters

The configuration file must contain following parameters. See Table 8-2.

**Table 8-2** Parameters for the Configuration File

| Parameter     | Description                                                             |
|---------------|-------------------------------------------------------------------------|
| ARCH_LOG_PATH | Path to ARCserve output file:<br>Example: ARCH_LOG_PATH=F:\temp\ARCHLOG |



**Table 8-2** Parameters for the Configuration File

| <b>Parameter</b>   | <b>Description</b>                                                                                                                                                                                                                                                                                                         |
|--------------------|----------------------------------------------------------------------------------------------------------------------------------------------------------------------------------------------------------------------------------------------------------------------------------------------------------------------------|
| MEDIA_LIST_PATH    | Path to the media list file.<br>Example: F:\temp\MEDIALIST.TXT                                                                                                                                                                                                                                                             |
| DRIVEPOOL_PATH     | Path to the device group list file.<br>Example: <i>Drivepool.txt</i>                                                                                                                                                                                                                                                       |
| JOB_LIST_PATH      | Path to the job list file.<br>Example: <i>Joblist.txt</i>                                                                                                                                                                                                                                                                  |
| DAS_SERVER         | DAS server name.<br>Example: DASSERVER=AMU                                                                                                                                                                                                                                                                                 |
| DAS_CLIENT         | DAS client name.<br>Example: DASCLIENT=WIN95                                                                                                                                                                                                                                                                               |
| ACI_MEDIA_TYPE     | Name of the ACI media type used for all ACI calls.<br>Example: 4MM                                                                                                                                                                                                                                                         |
| MOUNT_ERROR_VOLSER | If an ACI <b>MOUNT</b> command fails, since the required volume is still in the drive, ArcVirOp automatically issues the <b>DISMOUNT</b> command. ArcVirOp recognizes this because of the ACI error text. This error text must be specified via this parameter.<br>Example: mount failed the requested volseser is in use. |
| MOUNT_ERROR_DRIVE  | If an ACI <b>MOUNT</b> command fails, since the required drive is still in use, ArcVirOp automatically issues the <b>DISMOUNT</b> command. ArcVirOp recognizes this because of the ACI error text. This error text must be specified via this parameter.<br>Example: mount failed the requested drive is currently in use. |
| VOLSER_LENGTH      | Length of the serial number used by the AMU                                                                                                                                                                                                                                                                                |
| RETRY_INTERVALL    | Time interval before a retry of a mount or a dismount is executed after a connect problem                                                                                                                                                                                                                                  |
| RETRY_ATTEMPTS     | Number of retries of a mount or a dismount after a connect problem between the ArchVirOp PC and the AMU before a backup or restore will be cancelled                                                                                                                                                                       |
| [COMMAND_SECTION]  | Keyword, must be entered before specifying the backup and restore text pattern.                                                                                                                                                                                                                                            |

**Table 8-2** Parameters for the Configuration File

| <b>Parameter</b>          | <b>Description</b>                                                                                                                                                                                                                                                                                                                                                         |
|---------------------------|----------------------------------------------------------------------------------------------------------------------------------------------------------------------------------------------------------------------------------------------------------------------------------------------------------------------------------------------------------------------------|
| BACKUP_COMMAND            | Keyword, the backup text pattern must be specified in the next line.<br>Example: [%DATE] [%TIME] [%N] Please insert one of the following media in device group [%DRIVE]:<br>The parameter [%DRIVE] is extracted from the text pattern. Generally, the other place holders are not needed, however, they must be specified.                                                 |
| BACKUP_INCOMPLETE_COMMAND | Keyword, the backup incomplete pattern must be specified in the next line.<br>[%DATE] [%TIME] [%JOB] [%ERRORNR] job [%N]<br>backup procedure incomplete.                                                                                                                                                                                                                   |
| RESTORE_COMMAND           | Keyword, the restore text pattern must be specified in the next line.<br>Example: [%DATE] [%TIME] [%N] Insert medium [%S] serial number [%MEDIA] number [%N] from media DEFAULT in device group [%DRIVE].<br>The parameters [%MEDIA] and [%DRIVE] are extracted from the text pattern. Generally, the other place holders are not needed, however, they must be specified. |
| BACKUP_READY_COMMAND      | Keyword, the backup ready text pattern must be specified in the next line.<br>Example: [%DATE] [%TIME] [%JOBNR] job [%N]<br>backup was performed.                                                                                                                                                                                                                          |
| BACKUP_ABORT_COMMAND      | Keyword, the backup abort text pattern must be specified in the next line.<br>[%DATE] [%TIME] [%JOBNR] [%ERRORNR] job [%N]<br>backup procedure was aborted.                                                                                                                                                                                                                |
| RESTORE_READY_COMMAND     | Keyword, the restore ready text pattern must be specified in the next line.<br>[%DATE] [%TIME] [%JOBNR] job [%N] restore was performed.                                                                                                                                                                                                                                    |
| RESTORE_ABORT_COMMAND     | Keyword, the restore abort text pattern must be specified in the next line.<br>[%DATE] [%TIME] [%JOBNR] [%ERRORNR] job [%N]<br>restore procedure was aborted.                                                                                                                                                                                                              |
| BACKUP_STOPPED_COMMAND    | Keyword, the backup stopped text pattern must be specified in the next line.<br>[%DATE] [%TIME] [%JOBNR] [%ERRORNR] job [%N]<br>restore not finished.                                                                                                                                                                                                                      |



## **Example File ArcVirOp.cfg**

Refer to Figure 8-3 on page 8-24 for an example of the ArcVirOp.cfg file.

```

// Path
ARCH_LOG_PATH=G:\ARCSERVE.6\ARCH$SVR.LOG
MEDIA_LIST_PATH=MEDIALIST.TXT
DRIVEPOOL_PATH=DRIVEPOOL.TXT
JOB_LIST_PATH=JOBLIST.TXT
// DAS
DAS_SERVER=TOWER
DAS_CLIENT=WIN95
ACI_MEDIA_TYPE=4mm
MOUNT_ERROR_VOLSER=mount failed: The requested volser is in use
MOUNT_ERROR_DRIVE=mount failed: The requested drive is currently
in use
// EXTRA
VOLSER_LENGTH=6
RETRY_INTERVALL=5
RETRY_ATTEMPT=180
//Definition of the formats for individual commands
//-----
[COMMAND_SECTION]
BACKUP_COMMAND
[%DATE] [%TIME] [%JOBNR] Please insert one of the following media
in device group [%DRIVE]:
RESTORE_COMMAND
[%DATE] [%TIME] [%JOBNR] Insert medium [%S] serial number [%MEDIA]
number [%N] from media DEFAULT in device group [%DRIVE].
BACKUP_READY_COMMAND
[%DATE] [%TIME] [%JOBNR] job [%N] backup was performed.
BACKUP_ABORT_COMMAND
[%DATE] [%TIME] [%JOBNR] [%ERRORNR] job [%N] backup procedure was
aborted.
BACKUP_INCOMPLETE_COMMAND
[%DATE] [%TIME] [%JOBNR] job [%N] backup procedure incomplete
RESTORE_READY_COMMAND
[%DATE] [%TIME] [%JOBNR] job [%N] restore was performed.
RESTORE_ABORT_COMMAND
[%DATE] [%TIME] [%JOBNR] [%ERRORNR] job [%N] restore procedure was
aborted.
RESTORE_STOPPED_COMMAND
[%DATE] [%TIME] [%JOBNR] [%ERRORNR] job [%N] restore not finished

```

**Figure 8-3** Example of ArcVirOp.cfg File

---

---

For proper ArcVirOp operation, all configuration parameters must be parameterized correctly.

### **Example File Medialist.txt**

Serial numbers of empty tapes should be entered in *Medialist.txt*. When Arcserve requests an empty tape, ArcVirOp always tries to read a serial number from the *Medialist.txt* file.

The length of the serial number must correspond to the specified VOLSER\_LENGTH.

VOLSER\_LENGTH=6

For example:

185004

185005

185006

185007

185008

185009

185010

### **Example File Drivelist.txt**

This file must be edited by the user when device groups with several drives are created in Arcserve.

<Device group>=<DriveA> <DriveB> <DriveC>

DRVP\_01=D01

DRVP\_02=D02

D01=D01 D02 D03

HUGO=D01 D02 D03

OTTO=D04 D05 D06

D01=D01

### **Example File Config of the DAS Server on the AMU Controller (OS/2 Computer)**

Essentially, ArcVirOp is a DAS client that is connected to the DAS server via an ACI with a remote shell mechanism.

---

---

```
clinet client_name = AMUCLINET,
hostname = AMU,
request = complete,
volumes = ((ALL)),
drives = ((ALL)),
inserts = ((ALL)),
ejects = ((ALL)),
scratchpools = ((ALL))
```

```
client clinet_name = WIN95,
hostname = AMU,
requests = complete,
options = (avc, dismount),
volumes = ((ALL)),
drives = ((ALL)),
ejects = ((ALL)),
scratchpools = ((ALL))
```

## Start-up

After ArcVirOp is installed successfully and configured correctly, the program can be started. The program can be started via the command line or via the graphical user interface.

ArcVirOp can be started with the **-d** ("debug") option. With this option, ArcVirOp outputs all traces onto the screen.

## Sequence of Operations

A normal sequence of operation is as stated.

DAS/AMU is started

ARC/SERV is started

ArcVirOp is started

## Error, Warnings and Information

The following section contains information on errors, warnings and information that is written into the log file and/or displayed on the monitor.

## Message Construction

<(message type):(message number)> (message text)

---

---

## Message Type

The types of messages fall into three categories:

- I: Information
- W: Warning
- E: Error

## Messages

The following list of messages apply.

```
<I:1000> Main:: -> in
<I:1001> Main::Initialization
<I:1002> Main::Read configuration
<I:1003> Main::Initialization ready
<I:1004> Main::Waiting for commands ...
<I:1005> Main::Exit

<E:1000> Main::Abnormal program termination.

<I:2000> ARCObserver::recvCmd: -> in
<I:2001> ARCObserver::recvCmd: %d Bytes new
<I:2002> ARCObserver::recvCmd: No bytes to receive
<I:2003> ARCObserver::recvCmd: <- out - (%x)
<I:2004> ARCObserver::parseCommand: -> in
<I:2005> ARCObserver::parseCommand: <- out - (%#x) -
_eofPos (%x)
<I:2006> ARCObserver::checkCommandList: -> in
<I:2007> ARCObserver::checkCommandList: LIST[%d]: %s <-
> %s
<I:2008> ARCObserver::checkCommandList: <- out
<I:2009> ARCObserver::compareWords: -> in
<I:2010> ARCObserver::compareWords: <- out
<I:2011> ARCObserver::checkFile: -> in
<I:2012> ARCObserver::checkFile: <- out - (%l)
<I:2013> ARCObserver::scanBackupMedia: -> in
<I:2014> ARCObserver::scanBackupMedia -> fgets %s
<I:2015> ARCObserver::scanBackupMedia: -> sscanf
nScanNumber %d nMediaNumber %d Point %c Media %s Serial
%s Pool %s Num %
<I:2016> ARCObserver::scanBackupMedia: -> szSerial %s
```

```

<I:2017> ARCObserver::scanBackupMedia: -> end of
mediatable Before %l Act %l Delta %l
<I:2018> ARCObserver::scanBackupMedia: -> fseek %l
<I:2019> ARCObserver::scanBackupMedia: -> lPosAct %l
<I:2020> ARCObserver::scanBackupMedia: <- out - Media
found %d

<E:2000> ARCObserver::checkFile: Error by checkFile()

<I:3000> ConfigMgr::update: -> in
<I:3001> ConfigMgr::update: <- out - %d
<I:3002> ConfigMgr::parseConfigFile: -> in - File %s
<I:3003> ConfigMgr::parseConfigFile: <- out
<I:3004> ConfigMgr::parseConfigFile:
<I:3005> ConfigMgr::parseConfigFile: ARCH_LOG_PATH=%s
<I:3006> ConfigMgr::parseConfigFile: MEDIA_LIST_PATH=%s
<I:3007> ConfigMgr::parseConfigFile: DRIVEPOOL_PATH=%s
<I:3008> ConfigMgr::parseConfigFile: JOB_LIST_PATH=%s
<I:3009> ConfigMgr::parseConfigFile: DAS_SERVER=%s
<I:3010> ConfigMgr::parseConfigFile: DAS_CLIENT=%s
<I:3011> ConfigMgr::parseConfigFile: ACI_MEDIA_TYPE=%s
<I:3012> ConfigMgr::parseConfigFile:
MOUNT_ERROR_VOLSER=%s
<I:3013> ConfigMgr::parseConfigFile:
MOUNT_ERROR_DRIVE=%s
<I:3014> ConfigMgr::parseConfigFile: VOLSER_LENGTH=%d
<I:3015> ConfigMgr::parseConfigFile: <- out
<I:3016> ConfigMgr::buildCommandList: -> in
<I:3017> ConfigMgr::buildCommandList: BACKUP_COMMAND
found
<I:3018> ConfigMgr::buildCommandList:RESTORE_COMMAND
found
<I:3019> ConfigMgr::buildCommandList:
BACKUP_READY_COMMAND found
<I:3020> ConfigMgr::buildCommandList:
BACKUP_ABORT_COMMAND found
<I:3021> ConfigMgr::buildCommandList:
RESTORE_READY_COMMAND found
<I:3022> ConfigMgr::buildCommandList:
RESTORE_ABORT_COMMAND found
<I:3023> ConfigMgr::buildCommandList <- out

```



---

---

```
<E:3000> ConfigMgr::parseConfigFile: ConfigFile %s could
not be opened

<I:4000> DASAdaptor::executeCommand: -> in
<I:4001> DASAdaptor::executeCommand: <- out - rc %d
<I:4002> DASAdaptor::executeBackup: -> in
<I:4003> DASAdaptor::executeBackup: try Media %s
<I:4004> DASAdaptor::executeBackup: Media is BLANK try
MediaList.txt
<I:4005> DASAdaptor::executeBackup: try Drive %s
<I:4006> DASAdaptor::executeBackup: <- out - rc %d

<W:4000> DASAdaptor::executeCommand: -> wrong command
identifier
<W:4001> DASAdaptor::executeBackup: Volser %s is in use!
Retry with another Volser.

<W:4002> DASAdaptor::executeBackup: no Blankmedia in
Medialist.txt
<W:4003> DASAdaptor::executeBackup: Volser %s is in use!
Retry with another Volser.
<W:4004> DASAdaptor::executeBackup -> Drive %s is in use.
<W:4005> DASAdaptor::executeBackup: Dismount failed:
<%d> - <%s>
<W:4006> DASAdaptor::executeBackup: Mount failed: <%d> -
<%s>
<W:4007> DASAdaptor::executeBackup: Drivepool %s is not
in Drivepool.txt
<W:4008> DASAdaptor::executeBackup: Retry Attempts = %d
of %d

<E:4005> DASAdaptor::executeBackup: Backup Abort from
ArcVirOp <%d>

<I:4007> DASAdaptor::executeRestore: -> in
<I:4008> DASAdaptor::executeRestore: try Drive %s
<I:4009> DASAdaptor::executeRestore: out - rc %d

<W:4008> DASAdaptor::executeRestore: Volser %s is in use.
<W:4009> DASAdaptor::executeRestore: Dismount failed:
<%d> - <%s>
<W:4010> DASAdaptor::executeRestore: Mount failed: <%d> -
```

```
<%s>
<W:4011> DASAdaptor::executeRestore: Drive %s is in
use.
<W:4012> DASAdaptor::executeRestore: Dismount failed:
<%d> - <%s>
<W:4013> DASAdaptor::executeRestore: Mount failed: <%d>
- <%s>
<W:4014> DASAdaptor::executeRestore: Drivepool %s is
not in Drivepool.txt
<W:4015> DASAdaptor::executeRestore: Retry Attempts =
%d of %d"

<E:4001> DASAdaptor::executeRestore: Restore Abort from
ArcVirOp <%d>

<I:4010> DASAdaptor::executeBackupEnd: -> in
<I:4011> DASAdaptor::executeBackupEnd: <- out

<W:4015> DASAdaptor::executeBackupEnd: Job %d is not in
Joblist.txt!

<I:4012> DASAdaptor::executeRestoreEnd: -> in
<I:4014> DASAdaptor::executeRestoreEnd: <- out - rc %d

<W:4016> DASAdaptor::executeRestoreEnd: Job %d is not
in Joblist.txt!

<I:4015> DASAdaptor::executeAciCall: -> in, Command %s
<I:4016> DASAdaptor::executeAciCall: %s,%s,%s,%s
<I:4017> DASAdaptor::executeAciCall: aci_call success:
%s
<I:4017> DASAdaptor::executeAciCall: <- out - rc %d - %s

<W:4017> DASAdaptor::executeAciCall: Error by aci_call:
-1 - %s

<E:4001> DASAdaptor::executeAciCall: Error by aci_call:
-2 - %s
<E:4002> DASAdaptor::executeAciCall: Error by aci_call:
-3 - connection problem
```

---

---

```
<E:4003> DASAdaptor::executeAciCall: Error by aci_call:
-4 - syntax failure
<E:4004> DASAdaptor::executeAciCall: Error by aci_call:
%d - %s

<I:5000> DriveListMgr::checkDrivePool: -> in - Pool %s
File %s
<I:5001> DriveListMgr::checkDrivePool: check %s
<I:5002> DriveListMgr::checkDrivePool: <- out - Found
drives %s

<W:5000> DriveListMgr::checkDrivePool: Drivepool %s is
not in Drivepool.txt

<I:5003> DriveListMgr::readDriveList: -> in
<I:5004> DriveListMgr::readDriveList: Drivepool %s
<I:5005> DriveListMgr::readDriveList: -> out - rc %d

<W:5001> DriveListMgr::readDriveList: no valid
Drivepool %s

<E:5000> DriveListMgr::readDriveList: fopen

<I:6000> JobListMgr::addJob: -> in - File %s jobNumber
%d DriveName %s
<I:6001> JobListMgr::addJob: <- out

<I:6002> JobListMgr::removeJob: -> in - File %s
jobNumber %d
<I:6003> JobListMgr::removeJob: check %d
<I:6004> JobListMgr::removeJob: <- out - sJobComment %s

<I:6005> JobListMgr::readJobList: -> in
<I:6006> JobListMgr::readJobList: job %s
<I:6007> JobListMgr::readJobList: <- out - rc %d

<E:6000> JobListMgr::readJobList: fopen
```

---

---

```
<I:6008> JobListMgr::writeJobList: -> in
<I:6009> JobListMgr::writeJobList: <- out - rc %d

<E:6001> JobListMgr::writeJobList: fopen

<I:7000> MediaListMgr::getNextMedia: -> in - File %s
<I:7000> MediaListMgr::getNextMedia: <- out - media %s

<I:7002> MediaListMgr::readMediaList: -> in
<I:7003> MediaListMgr::readMediaList: <- out - rc %d

<E:7000> MediaListMgr::readMediaList: fopen

<I:7003> MediaListMgr::writeMediaList: -> in
<I:7004> MediaListMgr::writeMediaList: <- out - rc %d

<E:7001> MediaListMgr::writeMediaList: fopen
```

**Figure 8-4** Example of Error, Warning and Information Messages

---

---

# NETWORKER NT

This section describes the Networker NT.

## Installation

For a detailed description, refer to the *Networker Administration Guide*.

- Step 1** Install DAS and ACI
- Step 2** Configure DAS and ACI
- Step 3** Start the AMU and the DAS-Server
- Step 4** Check to make sure the connection from ACI to DAS is working. This can be done by sending **dasadmin qversion**.
- Step 5** Allocate the drives for the NT clients (dasadmin allocd Drive UP clientname)
- Step 6** Install Networker as it is described in the Networker documentation

## Configuration

Be sure that the SCSI-connections to the drive are correct. The number of devices that can be supported from the networker depends on the networker server configuration.

- Step 1** Define the media type in the environment variable DAS\_MEDIUM at Control Panel/System/Environment.
- Step 2** Add an ADIC Silo library to the Networker

- 
- 
- Change to the networker installation directory\nsr\bin directory
  - Type jbconfig
  - follow the instruction  
Choose a STL Silo library as jukebox and SAS Silo types. Be sure that you know which is the hostname where the DAS-Server is running and where the STL-library (libstlemass.dll) is placed. Also be sure that you know the pathname of the devices (you can see this by typing inquire in the same directory) and that you know the name of the devices that are used from AMU.

**Step 3** Add volumes to Networker with the **nsrjb-a-T 000/001-999** command. This is an example for a range from 000001 to 000999. Only the volsers which exist in the library will be added.

**Step 4** Define pools regarding the storage strategy

**Step 5** Label volumes for defined pools

# A

## Application Notes

|                                      |     |
|--------------------------------------|-----|
| Overview .....                       | A-3 |
| Notes on the Applications .....      | A-3 |
| Omniback .....                       | A-3 |
| Directory Path and Link .....        | A-3 |
| Environment Variables .....          | A-4 |
| Drives .....                         | A-4 |
| Logical Ranges of the I/O unit ..... | A-5 |
| Networker .....                      | A-6 |
| ArcServ for Novell .....             | A-6 |
| Windows-Clients (Remote Shell) ..... | A-6 |
| Media Types .....                    | A-7 |
| DAS Configuration Datasheet .....    | A-9 |



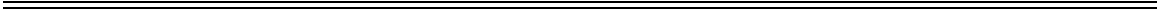



---

---

## Overview

This appendix includes notes on the applications, information on media types, and DAS configuration.

## Notes on the Applications

This section gives instructions for the configuration of certain applications.

### Omnibac

Omnibac is supplied by Hewlett Packard for the following operating systems:

- HP-UX 9.x
- HP-UX 10.x

### Directory Path and Link

Before setting links, check the versions of the files previously installed.

The following links are required for Omnibac with DAS. See Table A-1.

**Table A-1** Links Required for Omnibac with DAS

| HP-UX version | Original path                 | Linked path             |
|---------------|-------------------------------|-------------------------|
| 9.x           | /usr/local/aci/lib/libaci.sl  | /usr/omni/lib/libaci.sl |
| 10.x          |                               | /opt/omni/lib/libaci.sl |
| 9.x,<br>10.x  | /usr/local/aci/admin/dasadmin | /usr/local/das/admin/mm |



Use the `ln -s <original path> <linked path>` command to set up the symbolic link. Check the new link with the command `ls -l`.

---

---

## Environment Variables

The environment variables for Omniback are set in the following files. See Table A-2.

**Table A-2** Pathname by OS Version

| HP-UX version | Path and Filename |
|---------------|-------------------|
| 9.x           | /usr/omni/.omnirc |
| 10.x          | /opt/omni/.omnirc |

For the variable definition, see Figure A-1.

```
DAS_SERVER=TCP/IP Hostname AMU-PC
DAS_CLIENT=Variable def.in DAS-Server file CONFIG
```

**Figure A-1** Variable Definition

## Drive

The names of the drives in the Omniback configuration must match the assignments in the *config* file and the description in the graphical AMS configuration. For each drive is the configuration of a client in DAS necessary. Refer to Figure A-2 on page A-5.

Options for file *config*: options = (no\_avc,dismount)

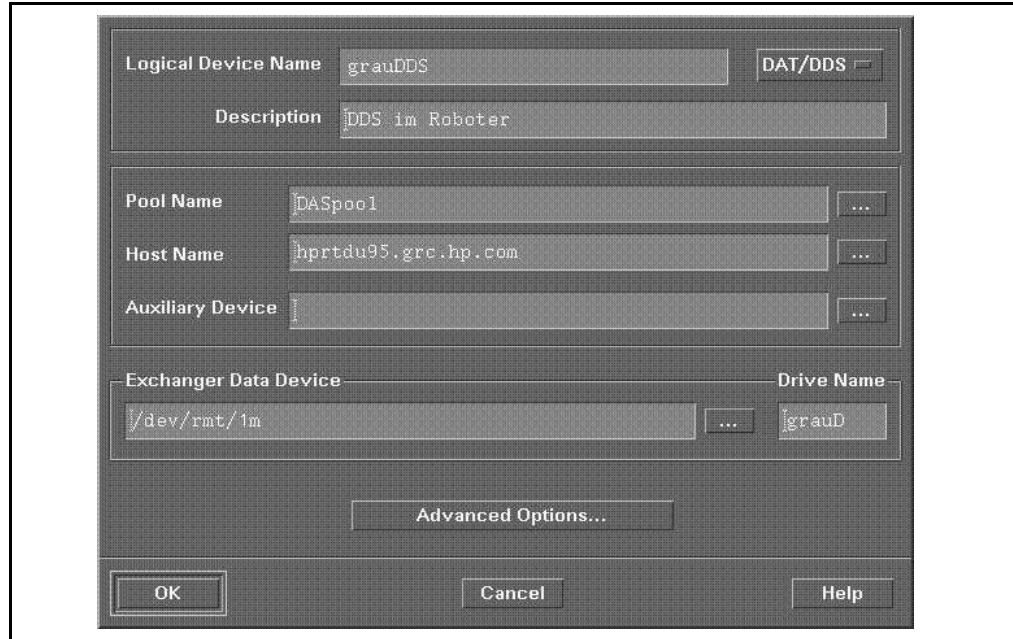

**Figure A-2** Omniback Jukebox Configuration Window

## Logical Ranges of the I/O unit

Access to the I/O unit for Omniback is defined in the file, see Table A-3.

**Table A-3** Pathname by OS Version

| HP-UX version | Path and Filename               |
|---------------|---------------------------------|
| 9.x           | /usr/omni/config/options/global |
| 10.x          | /etc/opt/omni/options/global    |

See Figure A-3 for an example of logical ranges.

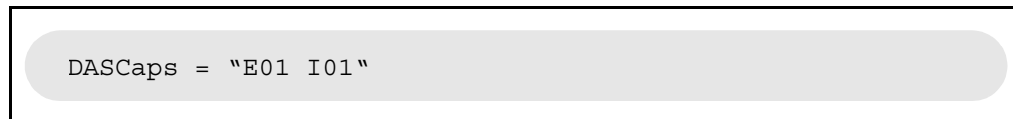

**Figure A-3** Example of Logical Ranges

The coordinates ranges for the Logical Ranges are specified in the AMS graphical configuration. Refer to the AMU Reference Manual.

---

---

## Networker

For the Clientname (Variable of the DAS Software) must be used the TCP/IP hostname. See Figure A-4.

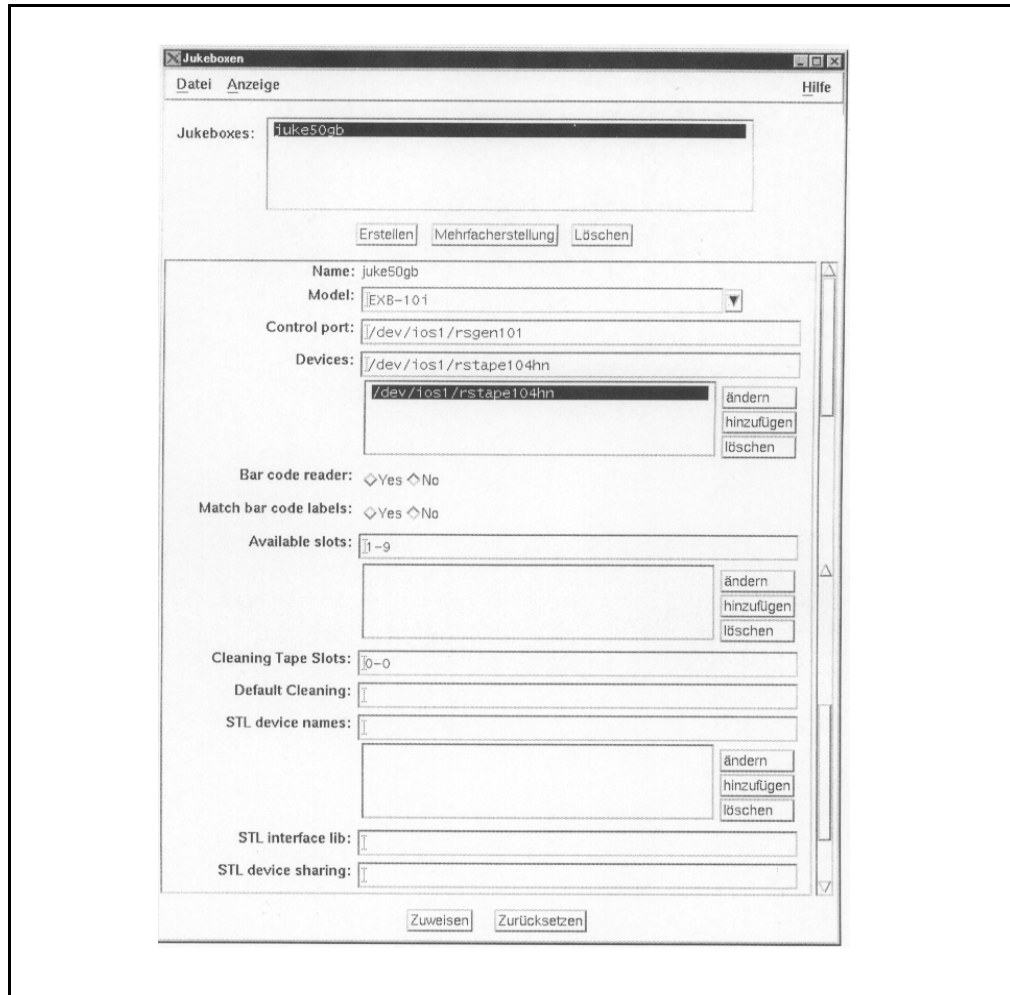

Figure A-4 Networker Jukebox Configuration

## ArcServ for Novell

Options for file *config*:  
options = (no\_avc,no\_dismount)

## Windows-Clients (Remote Shell)

Hostname and ip-address are not used in the Windows PC.  
The AMU hostname and IP-address must be used.

## Media Types

See Table A-4 for a list of supported media types.

**Table A-4** List of Supported Media Types

| Type             | Description                            | AMS type | DAS type   |
|------------------|----------------------------------------|----------|------------|
| 3480             | 1/2 Tape (different length available)  | C0       | 3480       |
| 3490             | 1/2 Tape (different length available)  | C0       | 3480       |
| 3490 E           | 1/2 Tape                               | C0       | 3480       |
| 3490E D-3        | 1/2 Tape (STK-Redwood)                 | C0       | 3480       |
| 3590             | 1/2 Tape (NTP=>New Tape Product)       | C2       | 3590       |
| 4MM-60M          | Digital Audio Tape (DAT)               | V2       | 4MM        |
| 4MM-90M          | Digital Audio Tape (DAT)               | V2       | 4MM        |
| 4MM-120M         | Digital Audio Tape DDS-2 (DAT)         | V2       | 4MM        |
| 4MM-125M         | Digital Audio Tape DDS-3 (DAT)         | V2       | 4MM        |
| 8MM              | 8 MM tape (different length available) | V1       | 8MM        |
| 8MM-112M         | 8mm Tape- 112m                         | V1       | 8MM        |
| 8MM-160M         | 8mm Tape- 160m                         | V1       | 8MM        |
| 8MM-54M          | 8mm Tape- 54m                          | V1       | 8MM        |
| Audio - cassette | Standard Audio Cassette                | VA       | AUDIO-TAPE |
| BetaCAM - Large  | Analog Tape Format                     | V9       | BETACAML   |
| BetaCAM - Small  | Analog Tape Format                     | V8       | BETACAM    |
| CD-Caddy         | CD with enclosure                      | C6       | CD         |
| D1-M             | D1 medium tape                         | V3       | D2         |
| D1-S             | D1 small tape                          | V4       | D2         |
| D2-M             | D2 medium tape                         | V4       | D2         |
| D2-S             | D2 small tape                          | V3       | D2         |

**Table A-4** List of Supported Media Types

| Type                    | Description                             | AMS type | DAS type |
|-------------------------|-----------------------------------------|----------|----------|
| Digital BetaCAM - Large | Digital Tape Format (like DTF-L)        | V9       | BETACAML |
| Digital BetaCAM - Small | Digital Tape Format (like DTF-S)        | V8       | BETACAM  |
| DLT Tape III XT         | Digital Linear Tape                     | C1       | DECDLT   |
| DLT CompacTape-III      | Digital Linear Tape                     | C1       | DECDLT   |
| DLT CompacTape-IV       | Digital Linear Tape                     | C1       | DECDLT   |
| DTF-L                   | DTF-Large tape, (Digital Tape Format)   | V7       | DTF      |
| DTF-S                   | DTF-Small tape, (Digital Tape Format)   | V6       | DTF      |
| OD-512                  | Optical Disk 5 1/4                      | O1       | OD-Thick |
| OD-R                    | Optical Disk 5 1/4                      | O0       | OD-Thin  |
| SD-3                    | 1/2 Tape (STK-Redwood)                  | C0       | 3480     |
| S-VHS                   | Super - Video Home Service              | V0       | VHS      |
| Sony AIT                | 8 mm Tape (different lengths available) | V1       | sony_ait |
| TRAVAN TR-1             | Streamer Tape                           | V5       | TRAVAN   |
| TRAVAN TR-2             | Streamer Tape                           | V5       | TRAVAN   |
| TRAVAN TR-3             | Streamer Tape                           | V5       | TRAVAN   |
| TRAVAN TR-4             | Streamer Tape                           | V5       | TRAVAN   |
| VHS                     | Video Home Service                      | V0       | VHS      |

---



---

# DAS Configuration Datasheet

Gather the configuration data and enter it in this form.

|                        |                  |
|------------------------|------------------|
| AMU-PC TCP/IP Address  |                  |
| AMU-PC TCP/IP hostname |                  |
| Hard disk ID1:         | Licence number1: |
| Hard disk ID1:         | Licence number1: |

DAS Client Information (OS/2 client or network client):

|                              |                                   |                                      |
|------------------------------|-----------------------------------|--------------------------------------|
| Client name                  |                                   |                                      |
| TCP/IP Address of the client |                                   |                                      |
| Client hostname              |                                   |                                      |
| Access privileges:           | basic <input type="checkbox"/>    | complete <input type="checkbox"/>    |
| Control options              | avc <input type="checkbox"/>      | no_avc <input type="checkbox"/>      |
|                              | dismount <input type="checkbox"/> | no_dismount <input type="checkbox"/> |
| drives                       |                                   |                                      |
| Volser                       |                                   |                                      |
|                              |                                   |                                      |
|                              |                                   |                                      |
|                              |                                   |                                      |
|                              |                                   |                                      |
|                              |                                   |                                      |
|                              |                                   |                                      |
|                              |                                   |                                      |
| Insertion ranges             |                                   |                                      |
| Ejection ranges              |                                   |                                      |
| Scratch pools                |                                   |                                      |





# Index

## - A -

- Access parameters
  - client ..... 5-42
- ACI ..... 2-4
  - installation ..... 4-24
- ACI messages ..... 6-90
- ACI\_MEDIA\_TYPE ..... 4-30
- ACI0001 ..... 6-90
- ACI0002 ..... 6-90
- ACI0003 ..... 6-91
- ACI0004 ..... 6-91
- ACI0005 ..... 6-92
- ACI0006 ..... 6-92
- ACI0007 ..... 6-93
- ACI0008 ..... 6-93
- ACI0011 ..... 6-94
- ACI0012 ..... 6-94
- ACI0013 ..... 6-95
- ACI0014 ..... 6-95
- ACI0015 ..... 6-95
- ACI0020 ..... 6-96
- ACI0021 ..... 6-96
- ACI0022 ..... 6-97
- ACI0023 ..... 6-97
- ACI0024 ..... 6-98
- Activating robotic controller in the AML ..... 5-41
- activating/deactivating the barcode reader ... 5-9
- Adding Drives ..... 8-6
- Address
  - ADIC ..... 1-5
  - ADIC/GRAU Storage Systems ..... 1-5
- ADSM VirOp ..... 8-3
  - Configuration ..... 8-5, 8-7
- DRM Support ..... 8-9
  - Shell Scripts ..... 8-9
    - drmsetup ..... 8-9
    - gcheckin ..... 8-10
    - gcheckout ..... 8-10
    - geject ..... 8-11
    - ginsert ..... 8-11
- EMM Commands without ADSM ..... 8-12
- Installation ..... 8-3
- Label Script ..... 8-12
- Required DAS Configuration ..... 8-8
- Scratch Handling ..... 8-8
- Setup ..... 8-5
  - Configure Drives ..... 8-5
    - Adding Drives ..... 8-6
    - Defining Drives ..... 8-6
    - Drive Availability ..... 8-6
    - Drive Naming ..... 8-6
  - Configure Libraries ..... 8-6
    - Default External Libraries ..... 8-7
    - Multiple ADSM Servers ..... 8-7
  - Help ..... 8-7
  - Install Options ..... 8-5
  - Update Drive Configuration ..... 8-7
  - Update Library Configuration ..... 8-7
- allocd (alld) ..... 5-7
- allocv ..... 5-8
- AMS
  - configuration ..... 4-20
- Appendix ..... A-3
- ARCHSERVE
  - Concept
    - Schematic Structure of the Work Environ-

|                                                          |      |
|----------------------------------------------------------|------|
| ment .....                                               | 8-14 |
| ARCHSERVE VirOp .....                                    | 8-14 |
| Concept .....                                            | 8-14 |
| Backup .....                                             | 8-15 |
| Restore .....                                            | 8-16 |
| Configuration .....                                      | 8-20 |
| ArcVirOp.cfg File .....                                  | 8-23 |
| Config File of DAS Server on the AMU<br>Controller ..... | 8-25 |
| Configuration Parameters .....                           | 8-20 |
| Drivepool.txt File .....                                 | 8-25 |
| Configuration Medialist.txt File .....                   | 8-25 |
| Design .....                                             | 8-16 |
| ARCObserver .....                                        | 8-19 |
| ArcVirOp .....                                           | 8-18 |
| ConfigMgr .....                                          | 8-18 |
| Ctrace .....                                             | 8-19 |
| DASAdaptor .....                                         | 8-19 |
| DriveListMgr .....                                       | 8-18 |
| JobListMgr .....                                         | 8-18 |
| MedialistMgr .....                                       | 8-18 |
| Object Diagram .....                                     | 8-16 |
| Installation .....                                       | 8-19 |
| Installation Files .....                                 | 8-19 |
| Installation Procedure .....                             | 8-20 |
| Start-Up .....                                           | 8-26 |
| Sequence of Operations .....                             | 8-26 |
| avc .....                                                | 4-12 |
| avoid volume contention .....                            | 4-12 |

**- B -**

|                      |      |
|----------------------|------|
| barcode .....        | 5-9  |
| basic requests ..... | 4-14 |

**- C -**

|                               |      |
|-------------------------------|------|
| cancel (can) .....            | 5-10 |
| catf .....                    | 5-10 |
| Change drive assignment ..... | 5-7  |
| clean .....                   | 5-12 |
| Cleaning media                |      |
| ejecting .....                | 5-17 |
| Client                        |      |
| access parameters .....       | 5-42 |
| authorization .....           | 2-9  |
| configuration .....           | 4-29 |
| number .....                  | 2-3  |
| operating parameters .....    | 5-43 |
| statement .....               | 4-13 |

|                                    |      |
|------------------------------------|------|
| Client access                      |      |
| basic .....                        | A-9  |
| complete .....                     | A-9  |
| Client management                  |      |
| commands .....                     | 5-3  |
| Client name .....                  | 4-13 |
| Command                            |      |
| cancel .....                       | 5-10 |
| client management .....            | 5-3  |
| DAS management .....               | 5-4  |
| verification .....                 | 2-9  |
| Communication                      |      |
| ACI .....                          | 2-8  |
| AMS .....                          | 2-8  |
| Comparing volsers in the AML ..... | 5-23 |
| complete requests .....            | 4-14 |
| config .....                       | 4-9  |
| options .....                      | 4-12 |
| range definition .....             | 4-11 |
| special characters .....           | 4-10 |
| structure and syntax .....         | 4-10 |
| config.sys .....                   | 4-7  |
| Configuration                      |      |
| ADSM .....                         | 8-7  |
| AMS .....                          | 4-20 |
| client .....                       | 4-29 |
| DAS .....                          | 4-26 |
| datasheet .....                    | A-9  |
| OS/2 PC .....                      | 4-26 |
| Windows NT .....                   | 4-28 |
| Configuration Management .....     | 2-8  |
| Configure Libraries .....          | 8-6  |
| Configuring I/O unit in AMS .....  | 4-21 |
| Control path .....                 | 2-3  |

**- D -**

|                              |     |
|------------------------------|-----|
| DAS                          |     |
| client .....                 | 2-4 |
| client access .....          | A-9 |
| commands .....               | 2-6 |
| communication .....          | 2-8 |
| functions .....              | 2-7 |
| installation .....           | 4-3 |
| software structure .....     | 2-4 |
| working environment .....    | 2-4 |
| DAS command processing ..... | 2-6 |
| DAS management               |     |
| commands .....               | 5-4 |
| DAS manager .....            | 2-5 |

|                   |      |         |      |
|-------------------|------|---------|------|
| DAS messages      | 6-18 | DAS4050 | 6-44 |
| DAS wait program  | 7-3  | DAS4051 | 6-44 |
| DAS_CLIENT        | 4-30 | DAS4052 | 6-45 |
| DAS_EJECTAREAFULL | 4-31 | DAS4053 | 6-45 |
| DAS_SERVER        | 4-30 | DAS4054 | 6-46 |
| DAS0001           | 6-18 | DAS4055 | 6-46 |
| DAS0002           | 6-19 | DAS4056 | 6-47 |
| DAS0003           | 6-19 | DAS4057 | 6-48 |
| DAS3000           | 6-20 | DAS4060 | 6-48 |
| DAS3001           | 6-20 | DAS4061 | 6-49 |
| DAS3002           | 6-21 | DAS4062 | 6-49 |
| DAS3003           | 6-21 | DAS4063 | 6-50 |
| DAS3004           | 6-22 | DAS4064 | 6-50 |
| DAS3020           | 6-22 | DAS4065 | 6-51 |
| DAS3021           | 6-23 | DAS4066 | 6-51 |
| DAS3022           | 6-23 | DAS4070 | 6-52 |
| DAS3023           | 6-24 | DAS4071 | 6-52 |
| DAS3500           | 6-24 | DAS4072 | 6-53 |
| DAS3501           | 6-25 | DAS4080 | 6-53 |
| DAS3502           | 6-25 | DAS4081 | 6-54 |
| DAS3503           | 6-26 | DAS4082 | 6-54 |
| DAS3504           | 6-26 | DAS4090 | 6-55 |
| DAS4000           | 6-27 | DAS4091 | 6-55 |
| DAS4001           | 6-27 | DAS4092 | 6-56 |
| DAS4002           | 6-28 | DAS4093 | 6-56 |
| DAS4003           | 6-29 | DAS4094 | 6-57 |
| DAS4004           | 6-29 | DAS4095 | 6-58 |
| DAS4005           | 6-30 | DAS4096 | 6-58 |
| DAS4006           | 6-31 | DAS4100 | 6-59 |
| DAS4007           | 6-31 | DAS4101 | 6-60 |
| DAS4010           | 6-32 | DAS4102 | 6-60 |
| DAS4011           | 6-33 | DAS4110 | 6-61 |
| DAS4012           | 6-33 | DAS4111 | 6-61 |
| DAS4013           | 6-34 | DAS4120 | 6-62 |
| DAS4020           | 6-35 | DAS4121 | 6-62 |
| DAS4021           | 6-35 | DAS4131 | 6-63 |
| DAS4022           | 6-36 | DAS4140 | 6-64 |
| DAS4023           | 6-36 | DAS4141 | 6-64 |
| DAS4024           | 6-37 | DAS4150 | 6-65 |
| DAS4030           | 6-38 | DAS4151 | 6-65 |
| DAS4031           | 6-38 | DAS4160 | 6-66 |
| DAS4032           | 6-39 | DAS4161 | 6-66 |
| DAS4033           | 6-39 | DAS4170 | 6-67 |
| DAS4040           | 6-40 | DAS4171 | 6-67 |
| DAS4041           | 6-40 | DAS4180 | 6-68 |
| DAS4042           | 6-41 | DAS4181 | 6-68 |
| DAS4043           | 6-42 | DAS4190 | 6-69 |
| DAS4044           | 6-42 | DAS4191 | 6-69 |
| DAS4045           | 6-43 | DAS4200 | 6-70 |

|                  |      |                                            |            |
|------------------|------|--------------------------------------------|------------|
| DAS4201          | 6-70 | getvoltoside                               | 5-20       |
| DAS4204          | 6-71 | insert                                     | 5-22       |
| DAS4205          | 6-71 | insert2                                    | 5-21       |
| DAS4210          | 6-72 | inventory                                  | 5-23       |
| DAS4211          | 6-72 | killamu                                    | 5-24       |
| DAS4220          | 6-73 | list                                       | 5-25       |
| DAS4221          | 6-74 | listd                                      | 5-31       |
| DAS4230          | 6-74 | listd2                                     | 5-27       |
| DAS4231          | 6-75 | listv                                      | 5-33       |
| DAS4232          | 6-75 | mount (mo)                                 | 5-34       |
| DAS4240          | 6-76 | pinvt                                      | 5-35       |
| DAS4241          | 6-76 | qversion                                   | 5-36       |
| DAS4242          | 6-77 | qvolsrange                                 | 5-36       |
| DAS4250          | 6-77 | rmf                                        | 5-39       |
| DAS4251          | 6-78 | robhome                                    | 5-40       |
| DAS4260          | 6-78 | robstat                                    | 5-41       |
| DAS4261          | 6-79 | scap                                       | 5-42       |
| DAS4270          | 6-79 | scop                                       | 5-43       |
| DAS4271          | 6-80 | scr_get                                    | 5-44       |
| DAS4272          | 6-80 | scr_info                                   | 5-45       |
| DAS4280          | 6-81 | scr_insert                                 | 5-46       |
| DAS4281          | 6-81 | scr_mount                                  | 5-47       |
| DAS4282          | 6-82 | scr_set                                    | 5-48       |
| DAS4290          | 6-82 | scr_unset                                  | 5-49       |
| DAS4291          | 6-83 | show                                       | 5-50       |
| DAS4292          | 6-83 | shutdown                                   | 5-52       |
| DAS4293          | 6-84 | switch                                     | 5-52       |
| DAS4295          | 6-84 | unload                                     | 5-53       |
| DAS4296          | 6-86 | view                                       | 5-54       |
| DAS4297          | 6-86 | DASCaps                                    | A-5        |
| DAS4300          | 6-87 | dasinst                                    | 4-3        |
| DAS4301          | 6-87 | Data path                                  | 2-3        |
| DAS4302          | 6-88 | DB/2 query tools                           | 7-4        |
| DAS4400          | 6-88 | Deactivating robotic controller in the AML | 5-40       |
| DAS4401          | 6-89 | Default External Libraries                 | 8-7        |
| DAS4402          | 6-89 | Defining Drives                            | 8-6        |
| DASADMIN command |      | derrno                                     | 6-99       |
| allocd           | 5-7  | Dismount                                   | 2-10       |
| allocv           | 5-8  | dismount                                   | 4-12, 5-13 |
| barcode          | 5-9  | Display                                    |            |
| cancel           | 5-10 | active commands                            | 5-25       |
| catf             | 5-10 | drive assignment                           | 5-27, 5-31 |
| clean            | 5-12 | version                                    | 5-36       |
| dismount         | 5-13 | volser information                         | 5-54       |
| eject            | 5-16 | volser reservation                         | 5-33       |
| eject2           | 5-14 | Displaying client parameters               | 5-50       |
| ejectcl          | 5-17 | Drive                                      |            |
| flip             | 5-18 | authorization                              | 4-14       |
| getvolsertodrive | 5-19 | cleaning                                   | 5-12       |

|                           |      |
|---------------------------|------|
| clearing                  | 5-13 |
| configuration in AMS      | 4-20 |
| Display assignment        | 5-31 |
| display assignment        | 5-27 |
| display associated volser | 5-19 |
| flipping OD               | 5-18 |
| loading cartridge         | 5-34 |
| operating drive buttons   | 5-53 |
| ranges                    | 4-14 |
| reservation               | 5-7  |
| Drive Availability        | 8-6  |
| Drive Naming              | 8-6  |
| DriveToVol statement      | 4-16 |
| drmsetup                  | 8-9  |
| Dual AMU                  | 2-12 |
| Dual DAS                  | 2-12 |

**- E -**

|                              |            |
|------------------------------|------------|
| EACIINT (29)                 | 6-113      |
| EAMU (7)                     | 6-102      |
| EAMUCOMM (8)                 | 6-103      |
| EAREAEMPTY (43)              | 6-119      |
| EAREAFULL (37)               | 6-117      |
| EBADCLIENT (19)              | 6-108      |
| EBADDYN (20)                 | 6-109      |
| EBADHOST (14)                | 6-106      |
| EBARCODE (44)                | 6-119      |
| ECANCELLED (27)              | 6-112      |
| ECLEANING (33)               | 6-115      |
| ECOORDINATE (42)             | 6-119      |
| EDASINT (28)                 | 6-113      |
| EDATABASE (47)               | 6-120      |
| EDEVEMPTY (12)               | 6-105      |
| EDRVOCCUPIED (5)             | 6-101      |
| EDYNFULL (17)                | 6-107      |
| EEXUP (40)                   | 6-118      |
| EHICAPINUSE (38)             | 6-118      |
| EINUSE (24)                  | 6-111      |
| EINVALID (2)                 | 6-100      |
| EINVALIDDEV (49)             | 6-121      |
| eject (ej)                   | 5-16       |
| eject2 (ej2)                 | 5-14       |
| ejectcl                      | 5-17       |
| Ejecting cleaning cartridges | 5-17       |
| Ejecting media               | 5-14, 5-16 |
| Ejection                     |            |
| ranges                       | 4-14       |
| EMOREDATA (30)               | 6-114      |
| ENOAREA (15)                 | 6-106      |

|                         |       |
|-------------------------|-------|
| ENODAS (11)             | 6-104 |
| ENODOUBLESIDE (39)      | 6-118 |
| ENODRIVE (4)            | 6-101 |
| ENOMATCH (31)           | 6-114 |
| ENOPOOL (36)            | 6-117 |
| ENOREQ (21)             | 6-109 |
| ENOROBOT (48)           | 6-121 |
| ENOSPACE (25)           | 6-111 |
| ENOTAUTH (16)           | 6-107 |
| ENOTFOUND (26)          | 6-112 |
| ENOTMOUNTED (23)        | 6-110 |
| ENOTREG (13)            | 6-105 |
| ENOTSUPPHCND (46)       | 6-120 |
| ENOVOLUME (3)           | 6-100 |
| Environment Variables   | 4-28  |
| Environment variables   | 4-30  |
| EOK (0)                 | 6-99  |
| EOTHERPOOL (32)         | 6-115 |
| EPROBDEV (41)           | 6-119 |
| EPROBVOL (6)            | 6-102 |
| ERETRYL (22)            | 6-110 |
| EROBOT (9)              | 6-103 |
| EROBOTCOMM (10)         | 6-104 |
| ERPC (1)                | 6-99  |
| Error handling          | 2-10  |
| dismount                | 4-17  |
| error handling          | 4-12  |
| ESWITCHINGPROG (35)     | 6-116 |
| ETIMEOUT (34)           | 6-116 |
| EUPDOWN (45)            | 6-120 |
| EUPELSE (18)            | 6-108 |
| Executing scratch mount | 5-47  |
| Explanation of icons    | 3-5   |

**- F -**

|                                    |      |
|------------------------------------|------|
| Fetch scratch medium               | 5-44 |
| flip                               | 5-18 |
| flipping optical disk in the drive | 5-18 |
| Foreign mount                      | 2-10 |
| cataloguing                        | 5-10 |
| removing from catalogue            | 5-39 |

**- G -**

|                  |      |
|------------------|------|
| gcheckin         | 8-10 |
| gcheckout        | 8-10 |
| geject           | 8-11 |
| getvolsertodrive | 5-19 |
| getvoltside      |      |

assigning a volser to an optical disk ..... 5-20  
 ginsert ..... 8-11  
 graphical configuration ..... 4-20

**- H -**

Help ..... 8-7  
 HICAP ..... 2-11  
 Host name ..... 4-14  
 HP-UX 10.x ..... A-3  
 HP-UX 9.x ..... A-3

**- I -**

Information symbols ..... 3-5  
 insert (in) ..... 5-22  
 insert2 ..... 5-21  
 inserting media ..... 5-21, 5-22  
 Insertion  
   ranges ..... 4-14  
 Installation ..... 4-25  
 installation  
   ACI ..... 4-24  
 inventory ..... 5-23, 5-35  
 IP address ..... 4-14

**- K -**

killamu ..... 5-24

**- L -**

list ..... 5-25  
 listd (ld) ..... 5-31  
 listd2 (ld2) ..... 5-27  
 listv ..... 5-33

**- M -**

Manual  
   Organization ..... 1-3  
   supplementary documentation ..... 1-4  
 Media  
   ejection ..... 2-11, 5-14, 5-16  
   insertion ..... 2-11, 5-21, 5-22  
   loading in drive ..... 5-34  
   removing from drive ..... 5-13  
 Mount ..... 2-10  
 mount (mo) ..... 5-34  
 Multiple ADSM Servers ..... 8-7

**- N -**

Networker ..... A-6  
 NETWORKER NT ..... 8-33  
   Configuration ..... 8-33  
   Installation ..... 8-33  
 NO\_ECOCODES (50) ..... 6-121  
 Notes on the applications ..... A-3

**- O -**

Omniback ..... A-3  
 Operating parameters  
   client ..... 5-43  
 Options ..... 4-14  
 os2sleep ..... 4-8, 7-3

**- P -**

PartInventory ..... 5-35  
 pinvt ..... 5-35  
 Portnumber ..... 4-17

**- Q -**

Querying volser ranges in the AML ..... 5-36  
 qversion ..... 5-36  
 qvolrange ..... 5-36

**- R -**

redundant AMU ..... 2-12  
 Removing scratch medium ..... 5-49  
 Request Manager ..... 2-5  
 Requests ..... 4-14  
 Reserving volsers ..... 5-8  
 retry\_keep ..... 4-17  
 rmf ..... 5-39  
 robhome ..... 5-40  
 robstat ..... 5-41  
 RPC server ..... 2-5  
 RPC test ..... 7-3

**- S -**

scap ..... 5-42  
 scop ..... 5-43  
 scr\_get ..... 5-44  
 scr\_info ..... 5-45  
 scr\_insert ..... 5-46  
 scr\_mount ..... 5-47  
 scr\_set ..... 5-48  
 scr\_unset ..... 5-49

---



---

|                                             |      |
|---------------------------------------------|------|
| Scratch media insertion .....               | 5-46 |
| Scratch pool                                |      |
| configuration in AMS .....                  | 4-23 |
| ranges .....                                | 4-15 |
| Scratch pool administration .....           | 2-11 |
| Scratch pool information .....              | 5-45 |
| Server statement .....                      | 4-16 |
| Setting scratch medium .....                | 5-48 |
| Shell Scripts .....                         | 8-9  |
| show .....                                  | 5-50 |
| Shut down                                   |      |
| AMU .....                                   | 5-24 |
| shutdown (shut) .....                       | 5-52 |
| Shutting down DAS .....                     | 5-52 |
| Special characters in the config file ..... | 4-10 |
| startup.cmd .....                           | 4-8  |
| switch .....                                | 5-52 |
| Switching to the dual DAS .....             | 5-52 |
| Symbols                                     |      |
| explanation .....                           | 3-5  |
| warnings .....                              | 3-3  |
| Symbols and conventions .....               | 1-4  |

**- T -**

|                         |     |
|-------------------------|-----|
| Target group .....      | 1-3 |
| Technical support ..... | 1-5 |

**- U -**

|                                    |      |
|------------------------------------|------|
| unload .....                       | 5-53 |
| Update Drive Configuration .....   | 8-7  |
| Update Library Configuration ..... | 8-7  |
| Utilities .....                    | 7-3  |

**- V -**

|                          |      |
|--------------------------|------|
| view .....               | 5-54 |
| Volser                   |      |
| display for drive .....  | 5-19 |
| ranges .....             | 4-14 |
| Volser information ..... | 5-54 |

**- W -**

|                |     |
|----------------|-----|
| Warnings ..... | 3-3 |
|----------------|-----|

